

Development of intelligent systems (RInS)

Robot sensors and TurtleBot

Danijel Skočaj

University of Ljubljana

Faculty of Computer and Information Science

Academic year: 2022/23

Robotic sensors

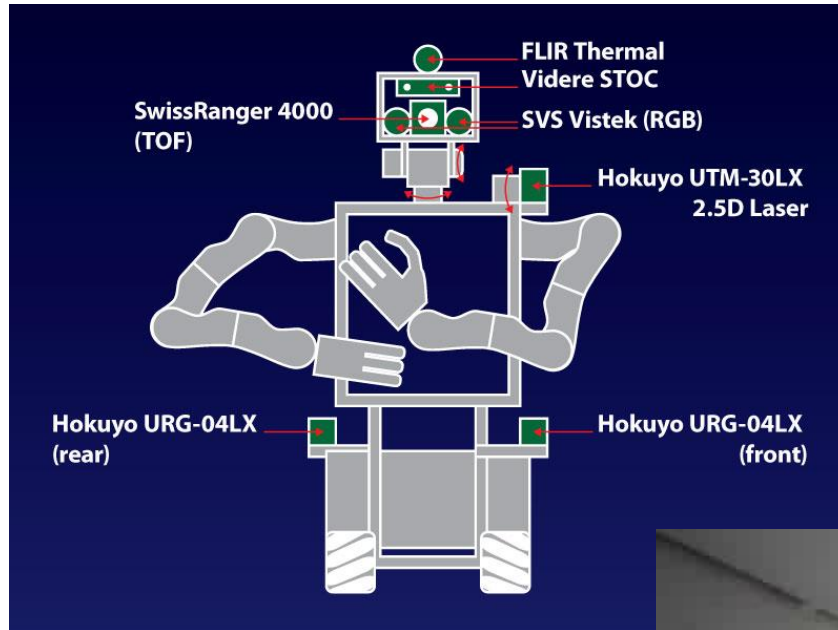

Sensors

Robot platforms

<http://ias.cs.tum.edu>



Sensors

- Equivalent to human senses
- Acquire information from the environment
- Electronic/mechanic/chemical device that maps the attributes of the environment into a quantitative measurement
- Robot can differentiate only between the states in the environment, which can be sensed differently

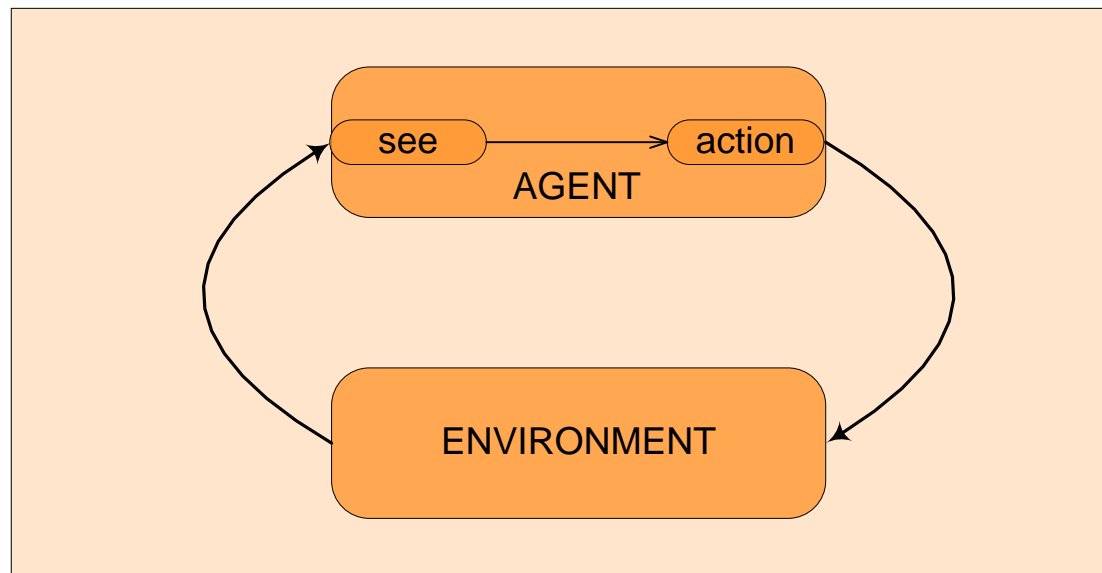

Perception action cycle

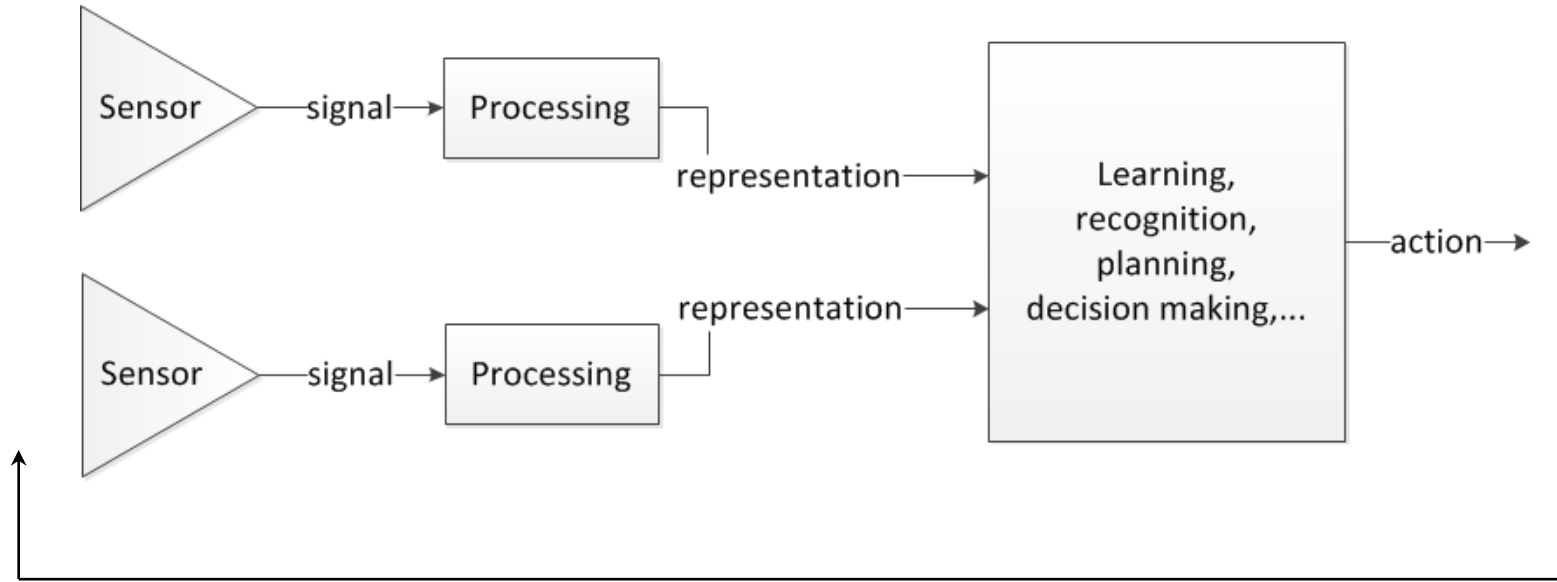

- Significant abstraction of the real world

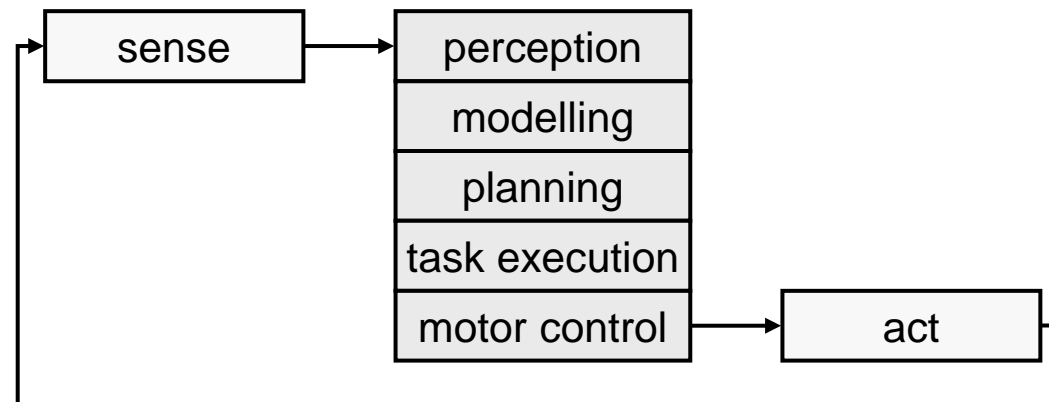

Senses

- Human senses:



- The list of robot senses is much longer!
 - Beyond human capabilities
 - Vision beyond visual spectrum (IR cameras, etc.)
 - Active vision (radar, LIDAR)
 - Hearing beyond the range 20 Hz-20 kHz (ultrasound)
 - Chemical analysis for better taste and smell
 - Measurement of temperature, humidity, illumination, radiation, pressure, volume, position, direction, acceleration, velocity, etc.

Classification of sensors

- Proprioceptive and exteroceptive sensors
 - Proprioceptive: measure internal states of the robot (battery status, position of wheels, angle between the segments in the robot arm)
 - Exteroceptive: measure the state of the environment (majority of the sensors)
- Passive and active sensors
 - Passive: only receive the energy from the environment (e.g., camera)
 - Active: also emit the energy in the environment (e.g., radar)
- Noninvasive and invasive sensors
 - Noninvasive (contactless): no contact with the object
 - Invasive: measurement with contact
- Visual, non-visual

Classification of sensors

General classification (typical use)	Sensor Sensor System	PC or EC	A or P
Tactile sensors (detection of physical contact or closeness; security switches)	Contact switches, bumpers	EC	P
	Optical barriers	EC	A
	Noncontact proximity sensors	EC	A
Wheel/motor sensors (wheel/motor speed and position)	Brush encoders	PC	P
	Potentiometers	PC	P
	Synchros, resolvers	PC	A
	Optical encoders	PC	A
	Magnetic encoders	PC	A
	Inductive encoders	PC	A
	Capacitive encoders	PC	A
Heading sensors (orientation of the robot in relation to a fixed reference frame)	Compass	EC	P
	Gyroscopes	PC	P
	Inclinometers	EC	A/P

A, active; P, passive; P/A, passive/active; PC, proprioceptive; EC, exteroceptive.

Classification of sensors

General classification (typical use)	Sensor Sensor System	PC or EC	A or P
Ground-based beacons (localization in a fixed reference frame)	GPS	EC	A
	Active optical or RF beacons	EC	A
	Active ultrasonic beacons	EC	A
	Reflective beacons	EC	A
Active ranging (reflectivity, time-of-flight, and geo- metric triangulation)	Reflectivity sensors	EC	A
	Ultrasonic sensor	EC	A
	Laser rangefinder	EC	A
	Optical triangulation (1D)	EC	A
	Structured light (2D)	EC	A
Motion/speed sensors (speed relative to fixed or moving objects)	Doppler radar	EC	A
	Doppler sound	EC	A
Vision-based sensors (visual ranging, whole-image analy- sis, segmentation, object recognition)	CCD/CMOS camera(s)	EC	P
	Visual ranging packages		
	Object tracking packages		

Sensors in robots

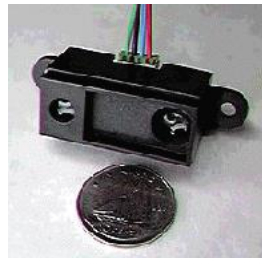

Digital Infrared Ranging



CDS Cell
Resistive Light Sensor



Piezo Bend Sensor



Pendulum Resistive
Tilt Sensors

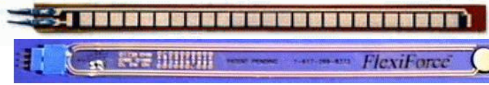

Resistive Bend Sensors



Metal Detector



Gas Sensor



Gieger-Muller
Radiation Sensor



Pyroelectric Detector



UV Detector

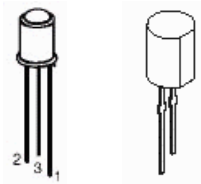

IR Pin
Diode



IR Sensor w/lens

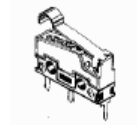

Limit Switch



Mechanical Tilt Sensors



Touch Switch

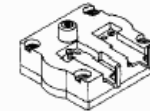

Pressure Switch

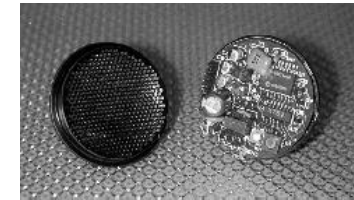

Miniature Polaroid Sensor

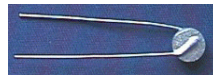

Thyristor



Magnetic Sensor



Gyro



Polaroid Sensor Board



IR Reflection
Sensor



IR Amplifier Sensor

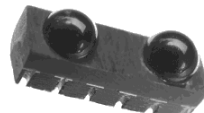

IRDA Transceiver

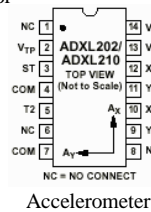

Magnetic Reed Switch

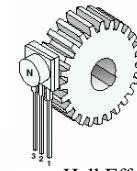

Hall Effect
Magnetic Field
Sensors

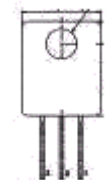

Lite-On IR
Remote Receiver

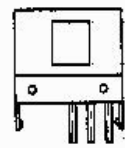

Radio Shack
Remote Receiver



IR Modulator
Receiver



Solar Cell

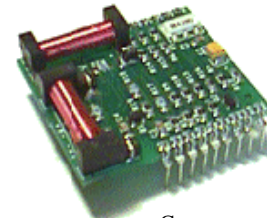

Compass

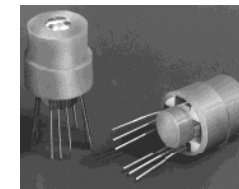

Compass

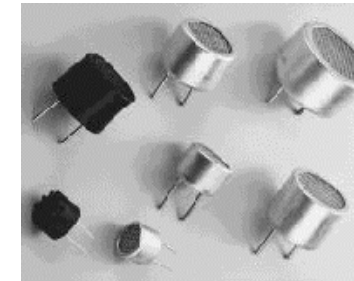

Piezo Ultrasonic Transducers

Cameras

Electromagnetic spectrum

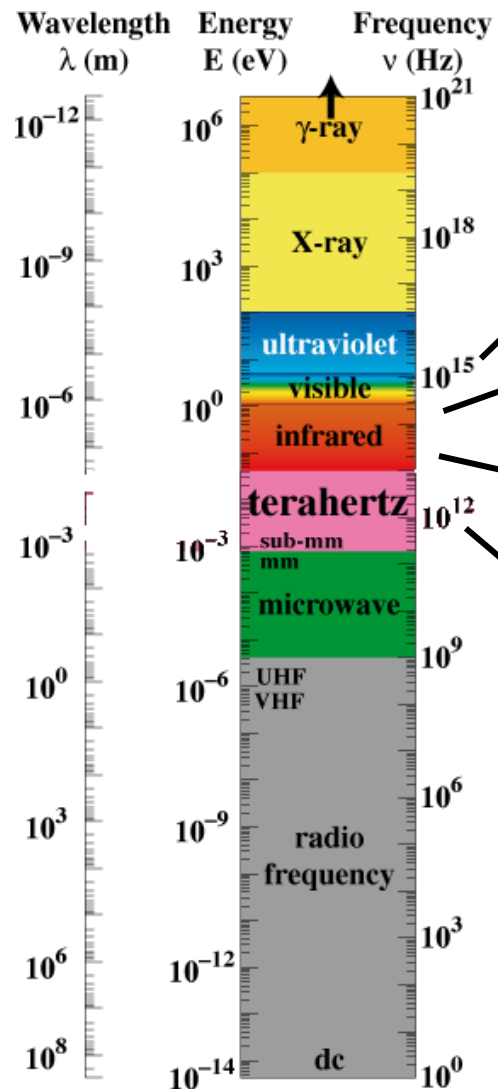

Visual
"light"



Near infrared
"light"
(NIR)



Long-wavelength
infrared "light"
(FLIR)

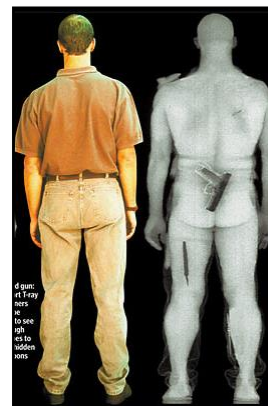

Terahertz
"light"
(T-ray)



Sensing EM radiation

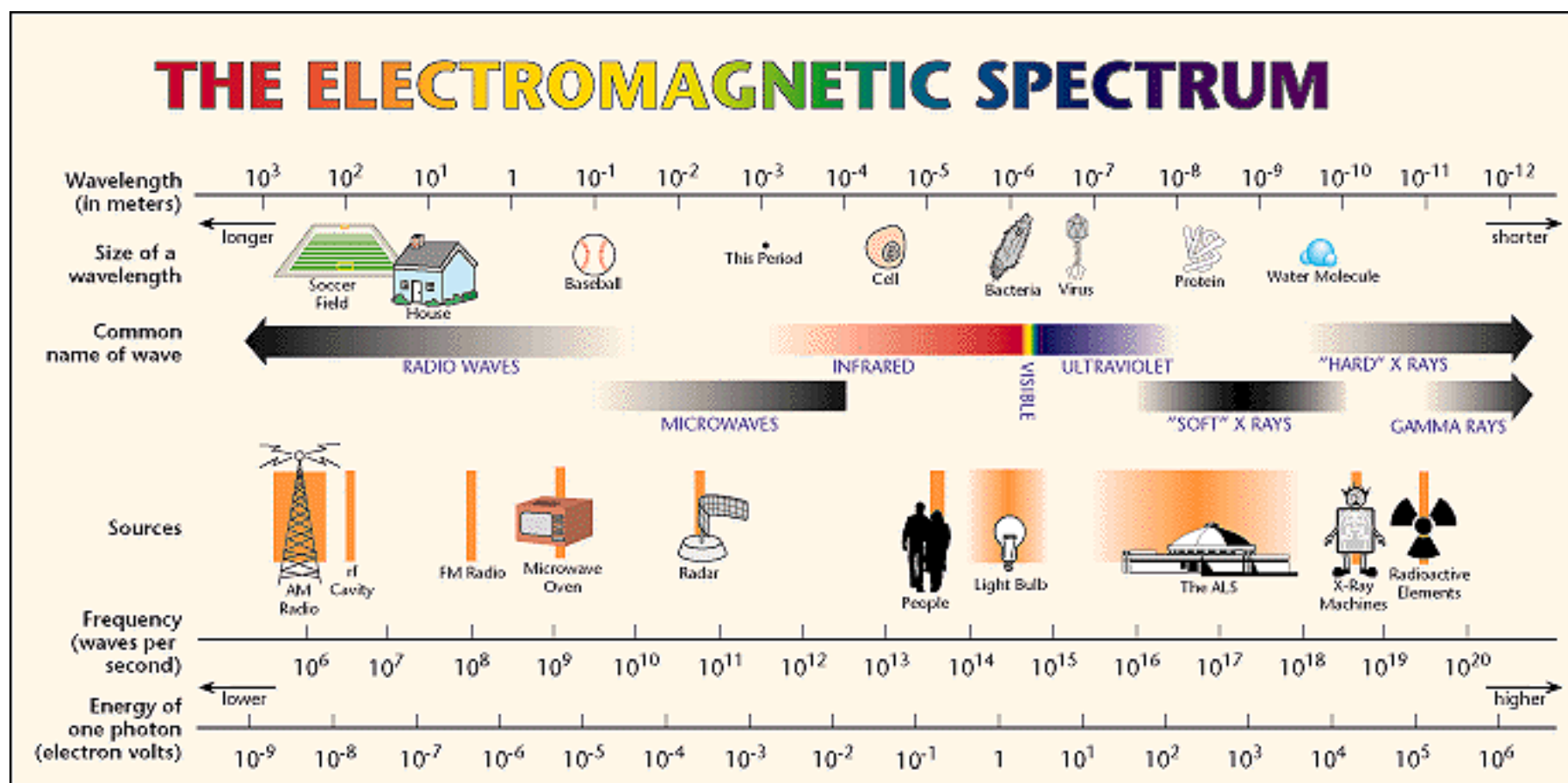

Resistive sensors

- Band sensor
 - The resistance changes by bending the sensor

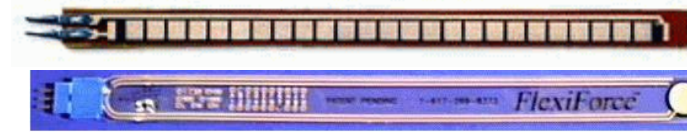

- Potentiometer
 - Position sensor in sliding or rotating mechanisms



- Photoresistor
 - Small resistance at high illumination
 - Light detection

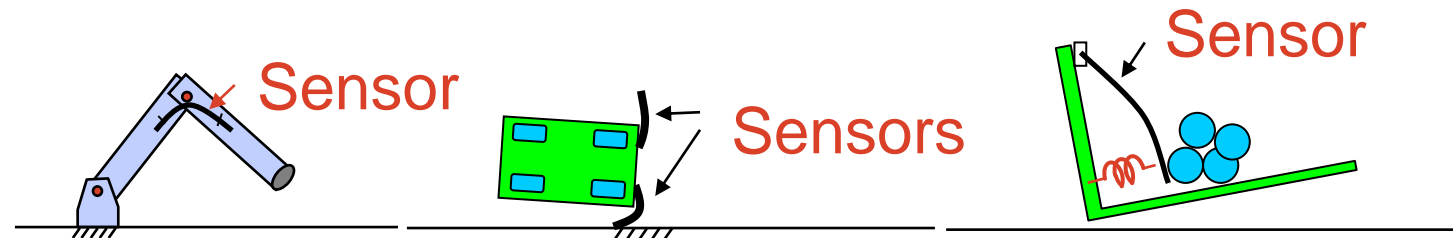

Infrared sensors

- Intensity IR sensors

- Emit and receive IR light
- Photo-transistor

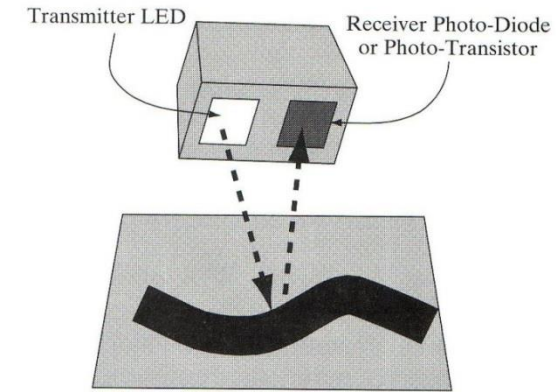
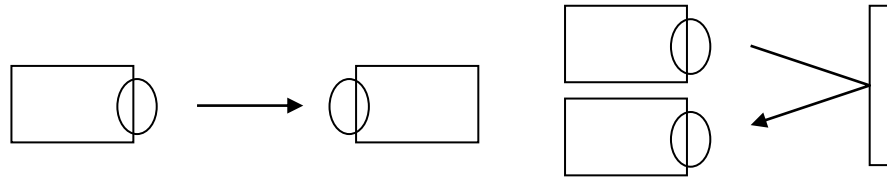

- Sensitive to daylight, reflections, distance
- Robust, cheap
- Application: object detection, optical encoder

- Modulated IR sensors

- Modulation and demodulation
- Pulse detection
- More robust
- IR remotes, etc.

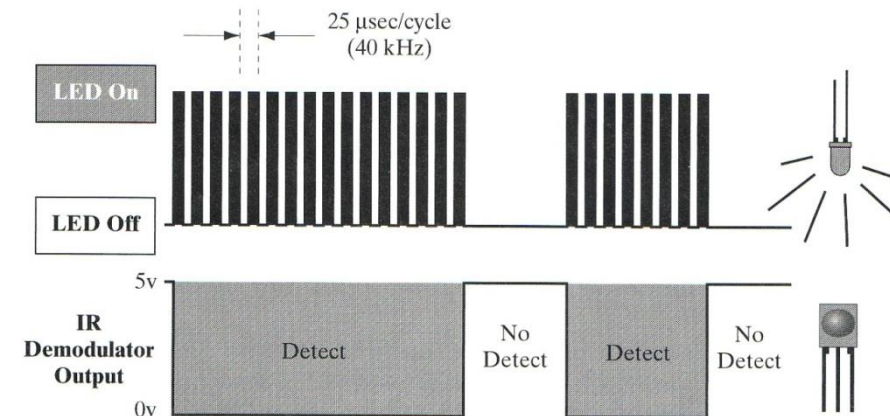

Infrared sensors

- Range sensors
- Measuring angle between the emitted and received light
-> triangulation

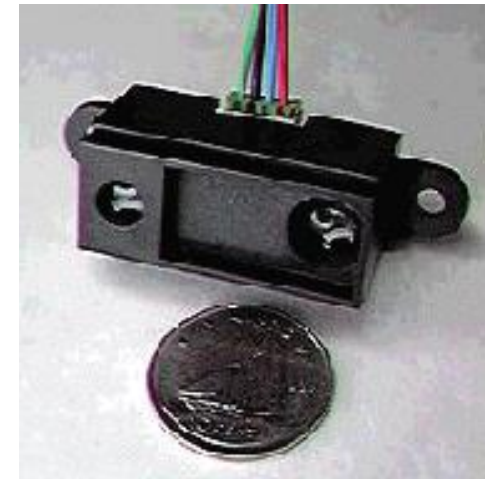
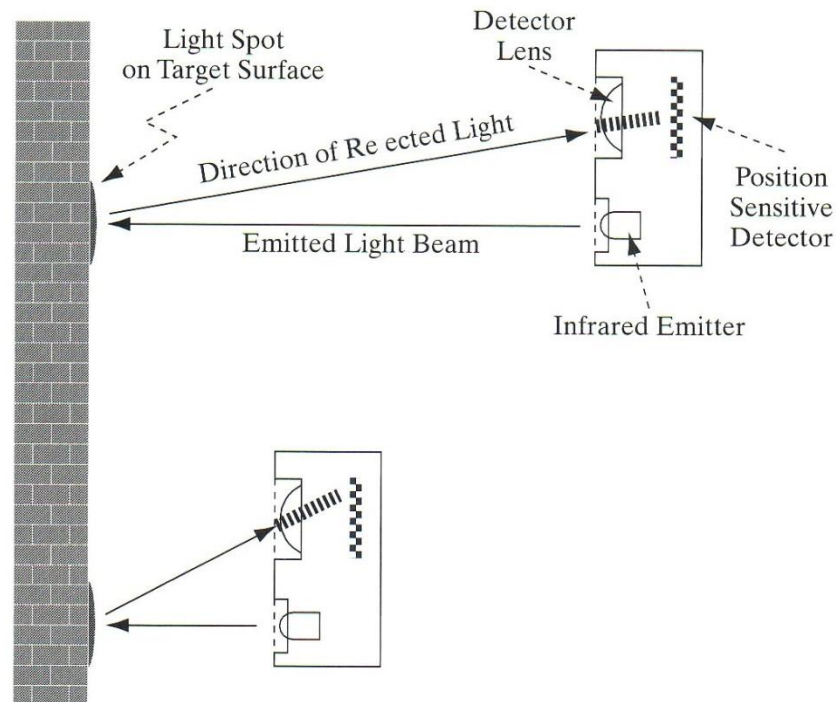

- Non-sensitive on ambient light

Measuring rotation

- Incremental Optical Encoders
 - Relative rotation

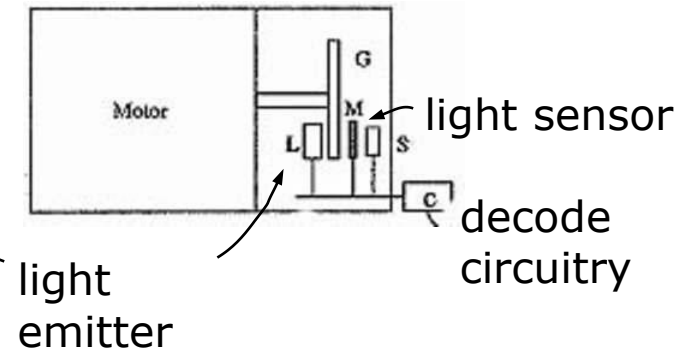
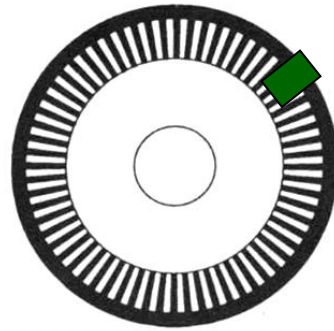

- Incremental Optical Encoders
- Absolute position
 - Gray code

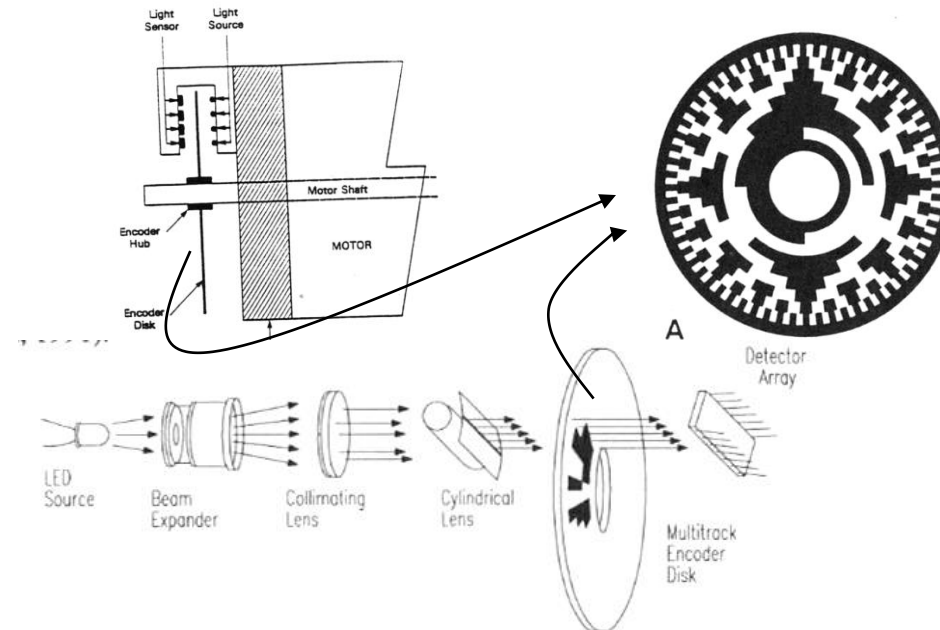

Inertial sensors

- Gyroscope
 - Measuring change of orientation
 - based on the principles of angular momentum
- Accelerometer
 - Measures acceleration, also orientation
 - Uniaxial, triaxial
 - Vibration sensor, vibration analysis, detection of orientation
 - Nintendo Wii, smart phones

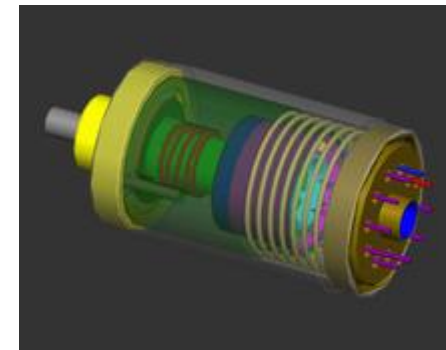

Compass

- Electronic compass
- Absolute orientation of the robot
 - N, S, E, W



GPS

- Global Positioning System
- 24 satellites at the height of 20200 km
- Atomic clock
- Satellite emit the time and position data
- At least 4 satellites should be visible
- Differential GPS – additional (terrestrial) signals are considered

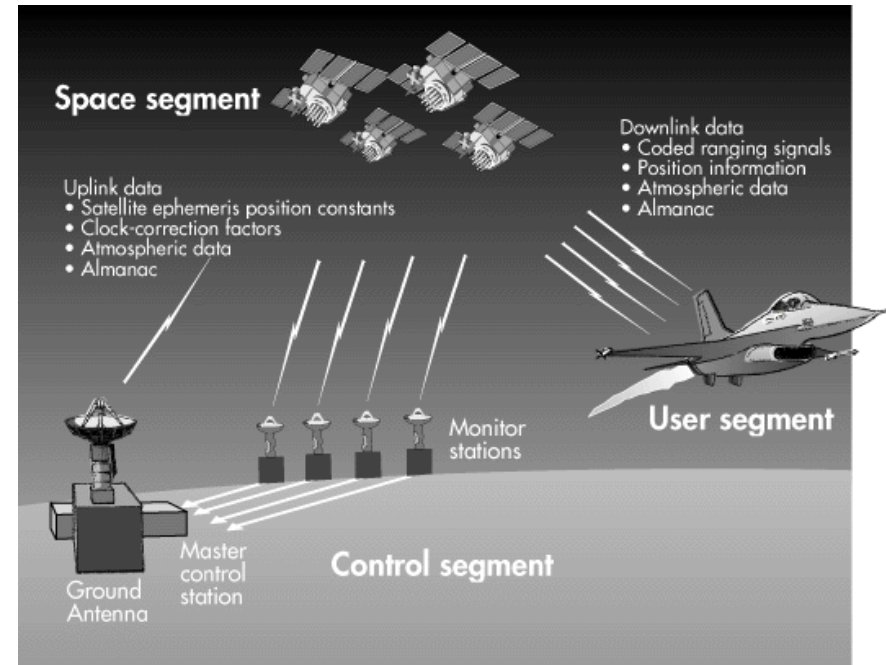

Tactile sensors

- Haptic technology
- Buttons, switches
- Bumpers (collision sensors)
- Touch sensors on the robot arm
- Different types:
 - Piezoresistive
 - Piezoelectric
 - Capacitive
 - Elastoresistive
- Artificial skin



Acoustic sensors

- Perception of sound

- Sonar



- Microphone

- Array of microphones
- Detection the sound direction



Range sensors

- Stereo vision
- Shape from X
- Coded light range sensor

- IR range sensor

- Time Of Flight sensors
 - Emit the signal, wait until it is back, measure the time
 - RADAR
 - SONAR
 - LIDAR
 - ToF cameras

Sonar

- Emits ultrasound
- Measure the time
- Bat, dolphin
- From a couple of cm to 30 m
- 30 degrees angular accuracy
- Quite slow: 200ms for 30m

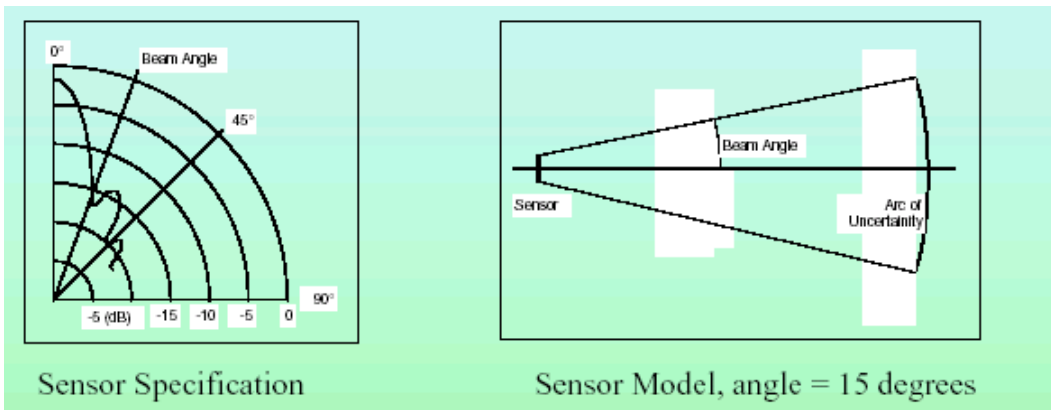
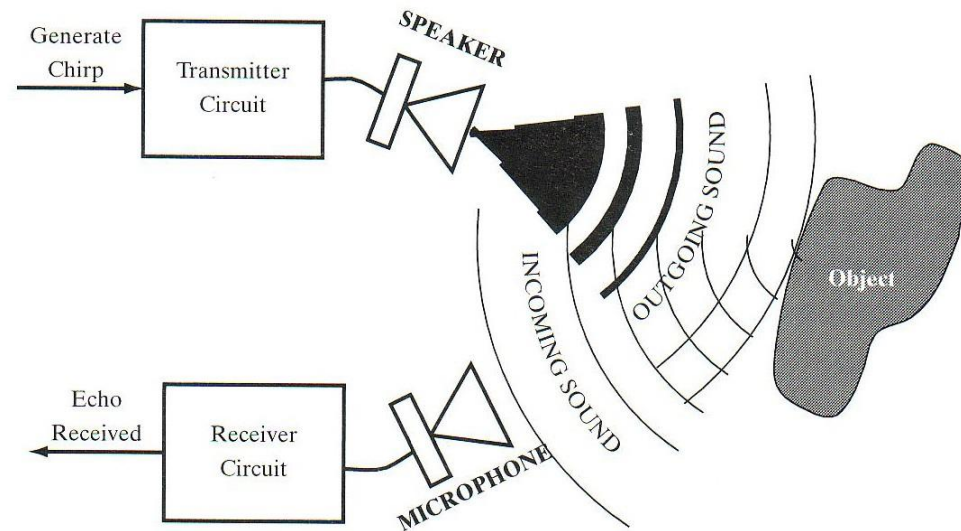

Sonar

- Usage:
Mapping of space

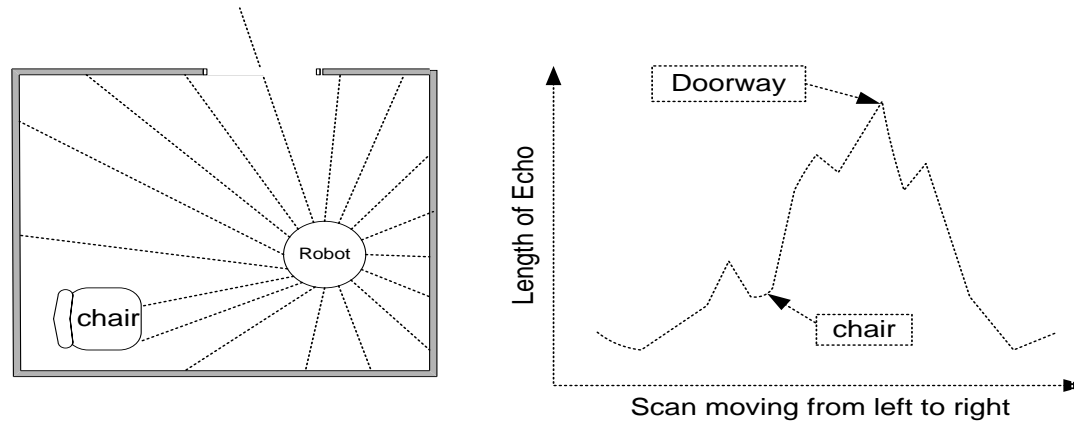

- Problem:
noise,
interference

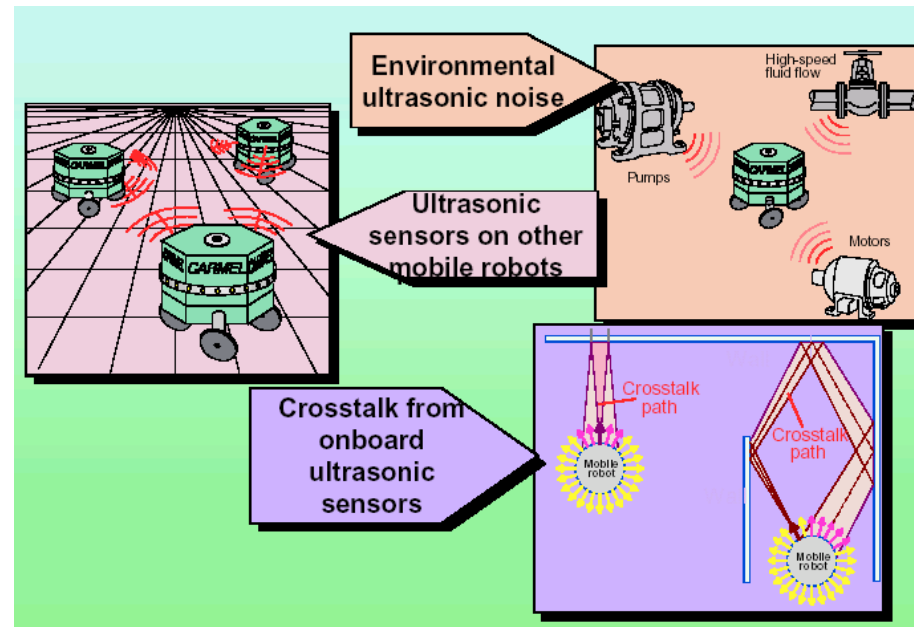

Laser range sensors

- LIDAR (**L**ight **D**etection **A**nd **R**anging)
- Emits laser pulses
- Rotating mirror – different angles (up to 180 degrees)
- Vertical movement – the entire hemisphere
- Better angular accuracy (0.25 degrees)
- Faster
- Different ranges, indoor, outdoor
- Robust

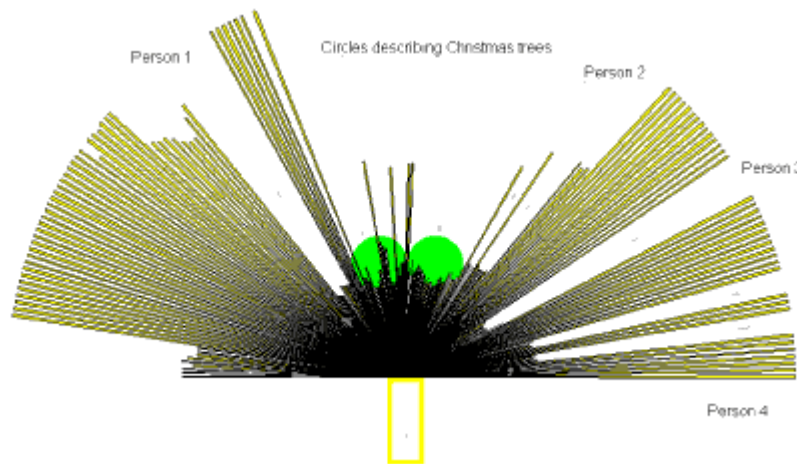
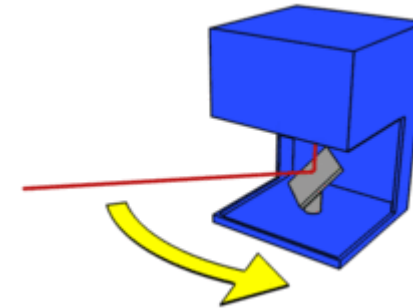

TOF cameras

- Time-of-flight cameras
- Time of pulse travel

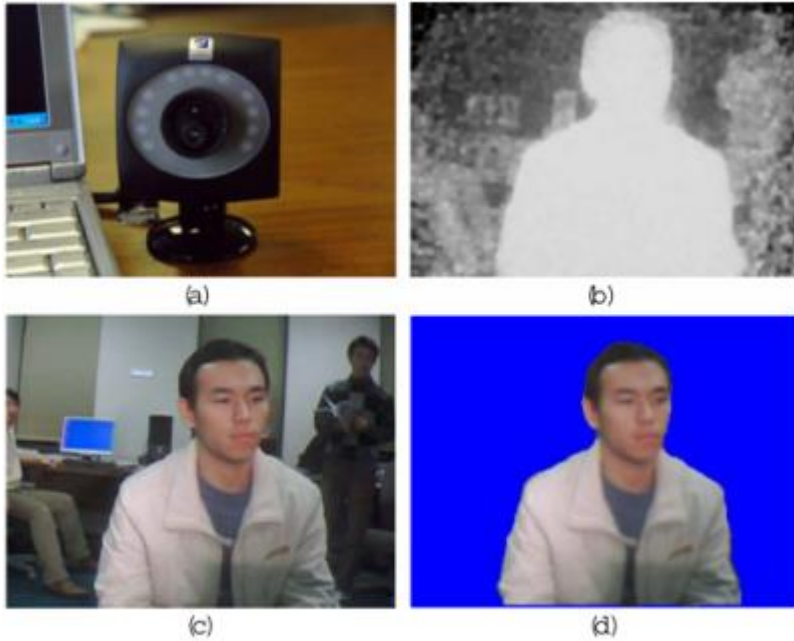

Coded light range sensor

- Camera and stripe projector

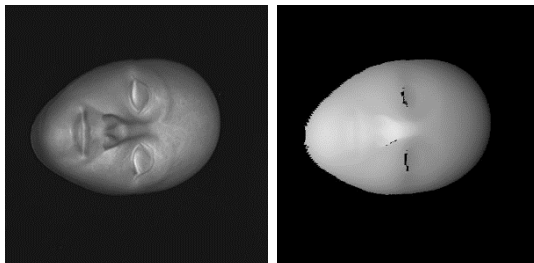
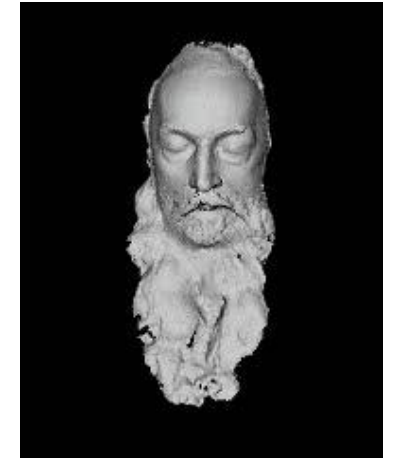
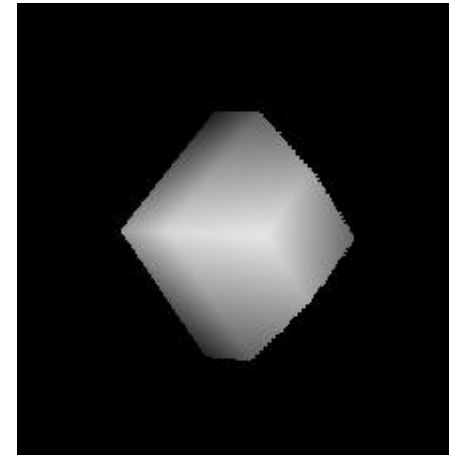
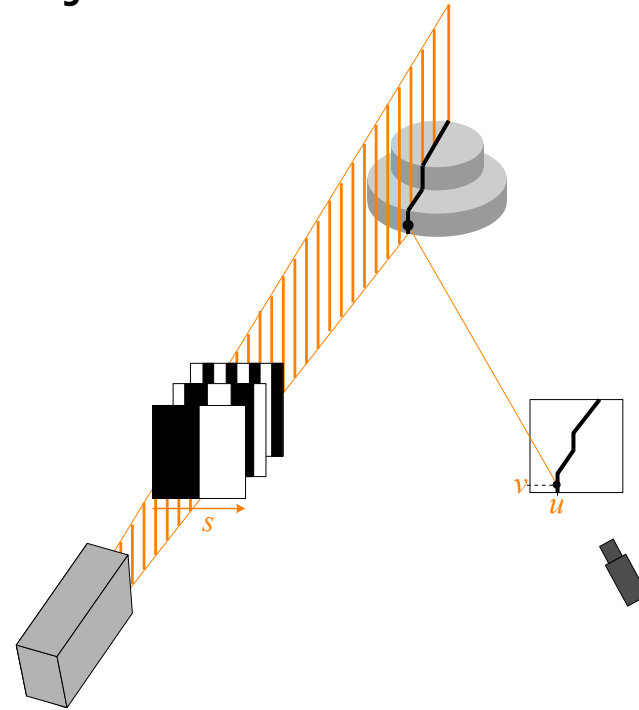
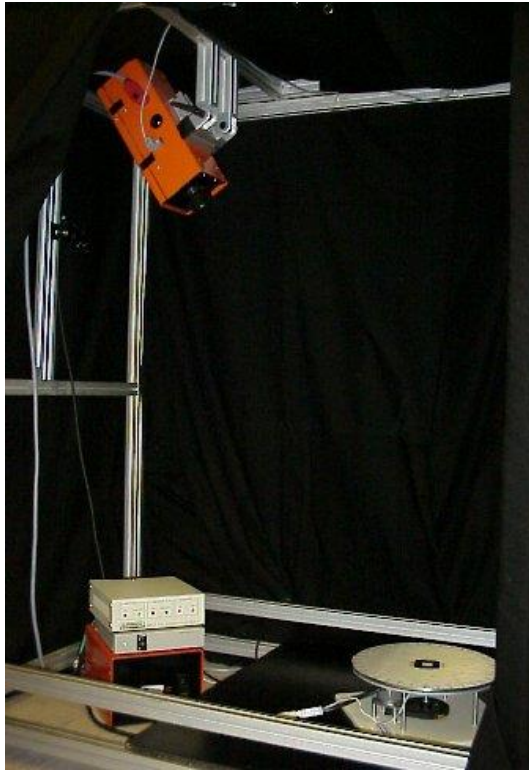

Color coding:

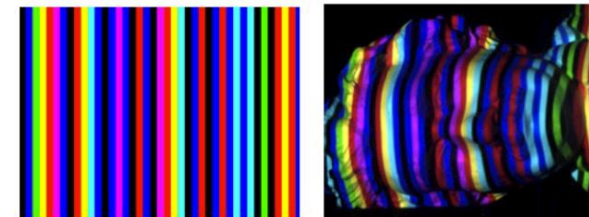

Structure from motion

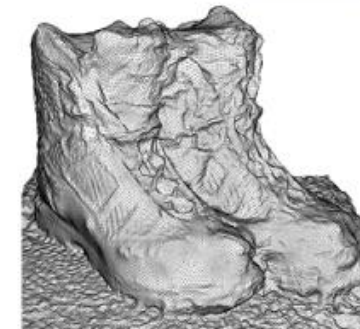
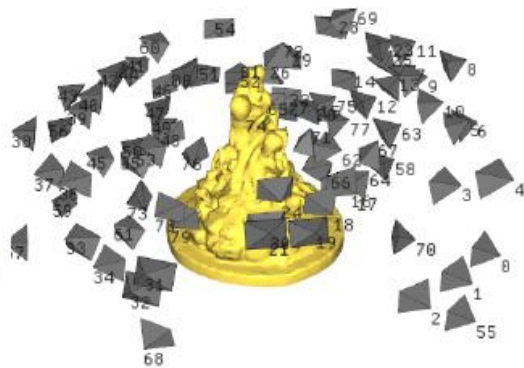
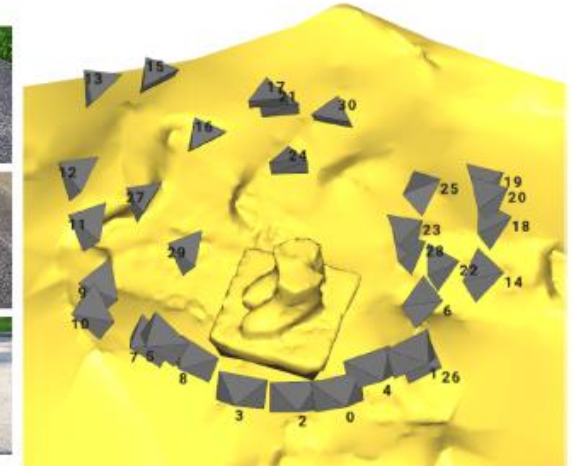
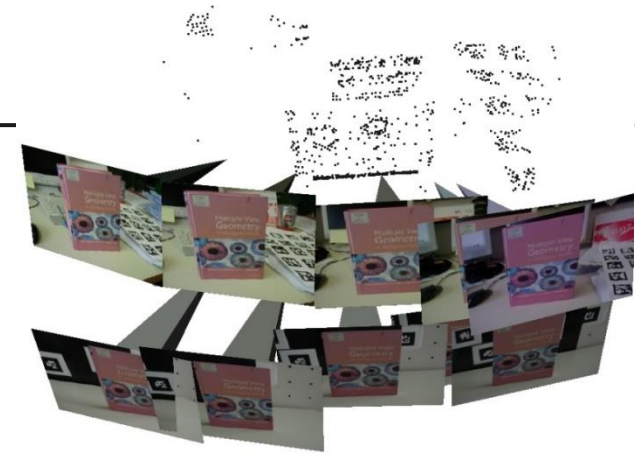
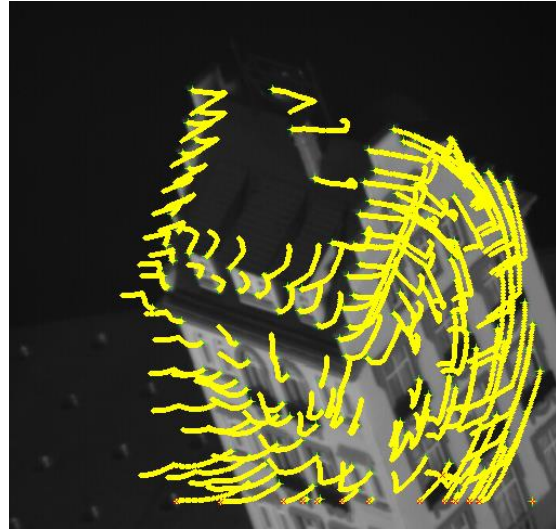

Other sensors

- Exteroceptive sensors
 - Wind speed
 - Temperature
 - Humidity
- Proprioceptive sensors
 - Battery level
 - Temperature of CPU, motors, sensors, etc.

Multimodal perception

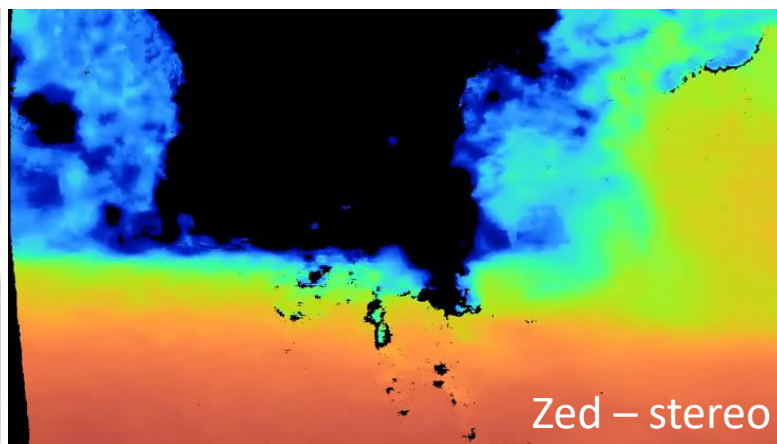
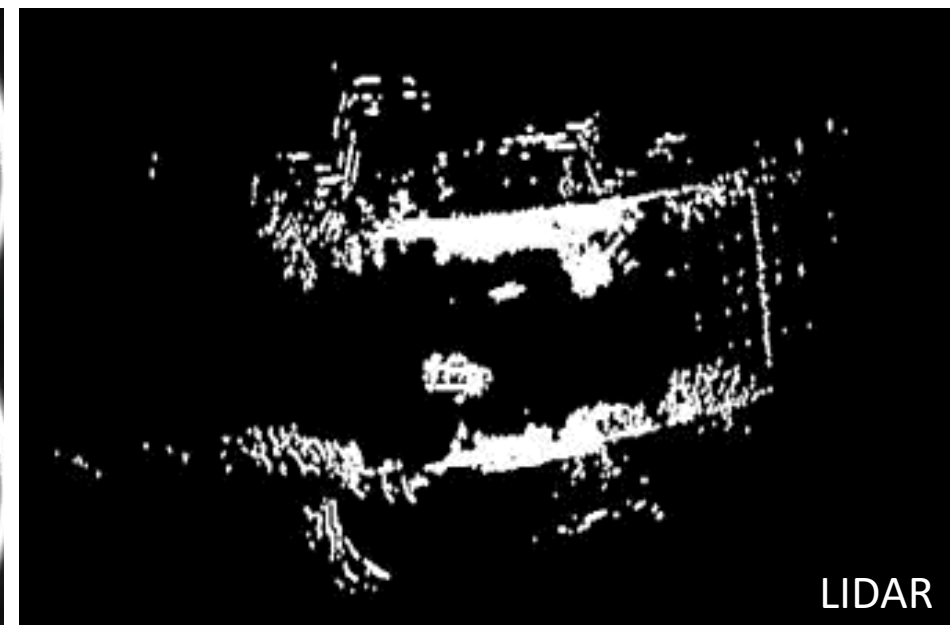

UL FE, FRI, Janez Perš, Matej Kristan

Sensor fusion

- One sensor often does not suffice
 - Noise
 - Limited accuracy
 - Non-reliability
 - Limited sensing range

=> Fuse the results of several sensors

- Sensor fusion: fusion on the level of sensors
 - Combine signals in one data structure on a low level
- Sensor integration: Fusion on the level of representations
 - Process data from every sensor independently and merge the obtained information on a higher level
- Fusion of data from multiple sources:
 - Measurement from different sensors
 - Measurement from different times
 - Measurement from different locations

TurtleBot++

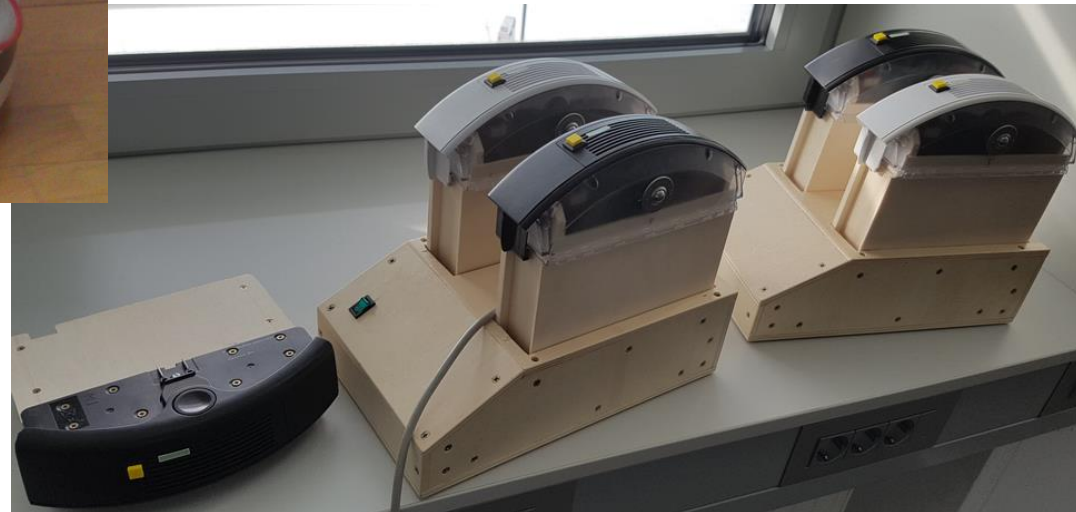

iRobot Roomba

- Actuators and sensors



Motors

- Changeable speed of the wheels
 - pulse-width modulation (PWM)

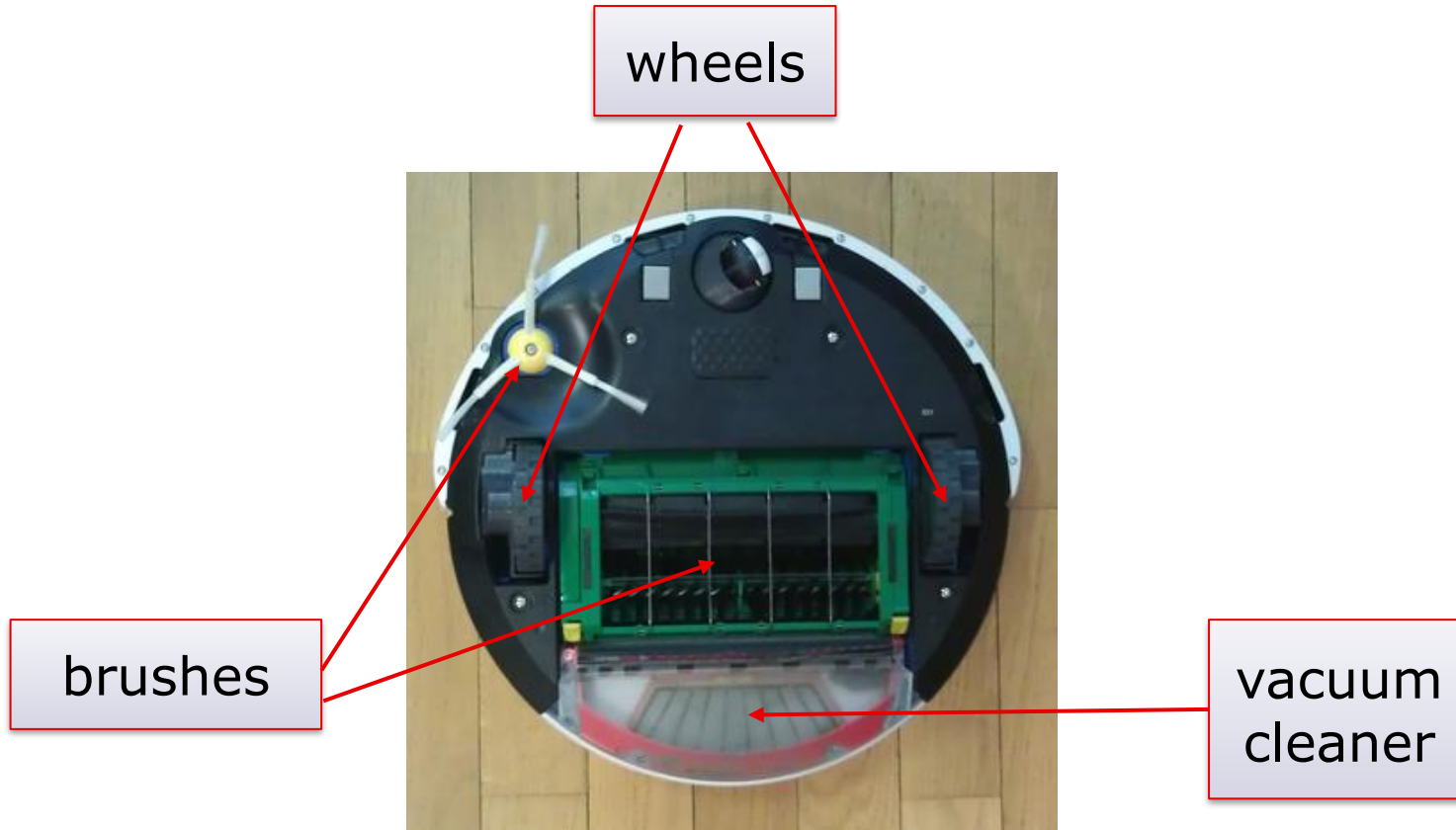

- On/off motors for brushes and vacuum cleaner

Wheels

- Differential control system
 - Two independently controlled wheels
- Electric motor
 - high speed
- 25:1 reduction
 - large torque

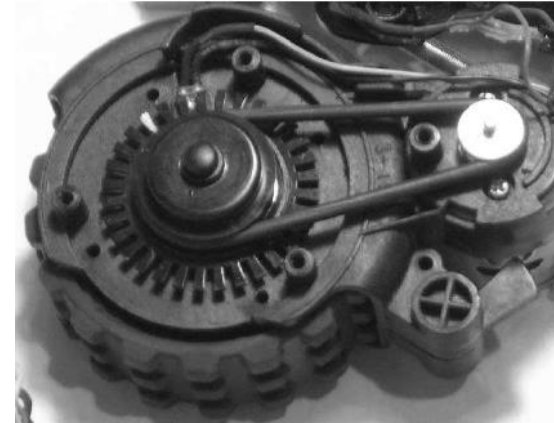

Sensors

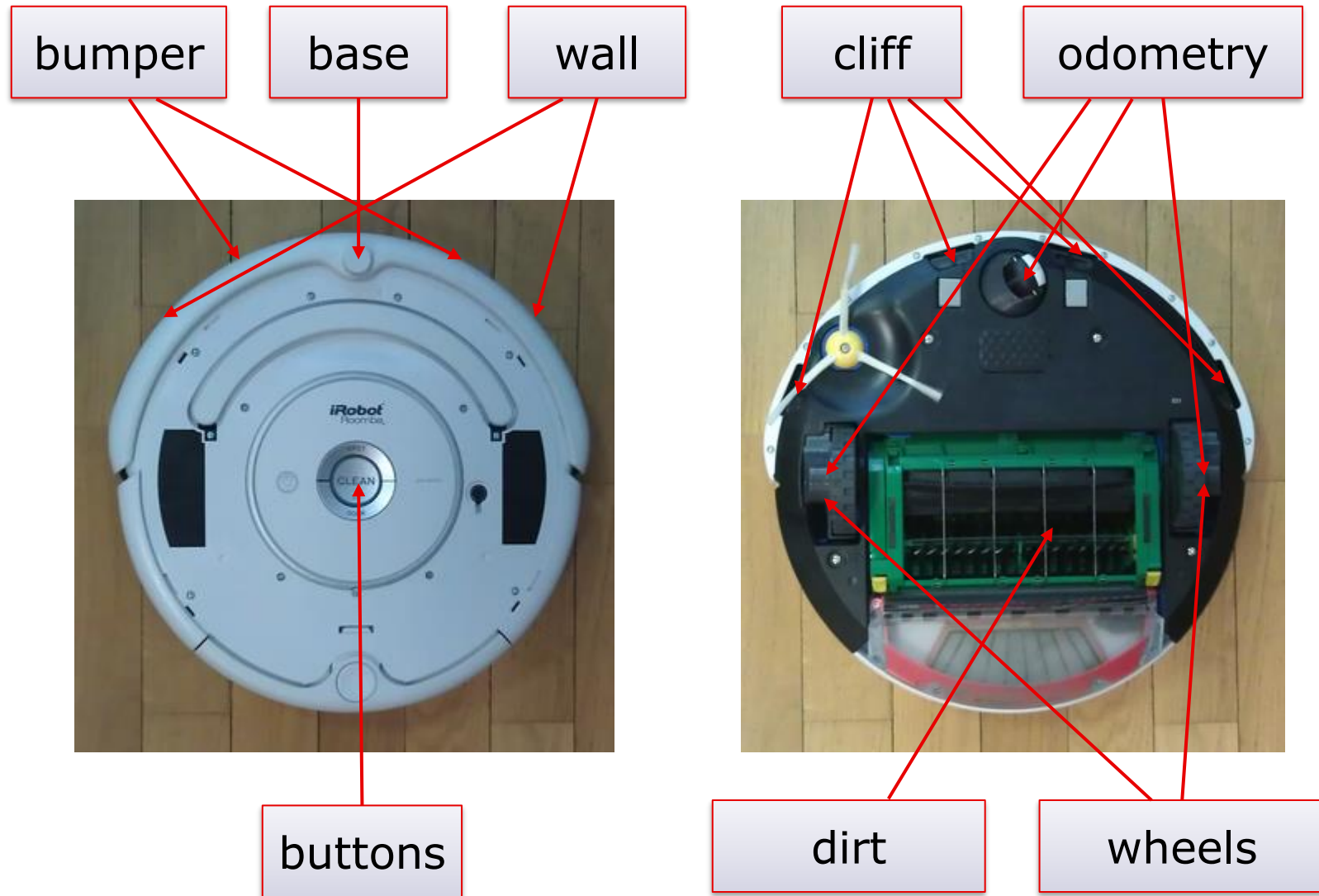

IR sensors

- IR sensors

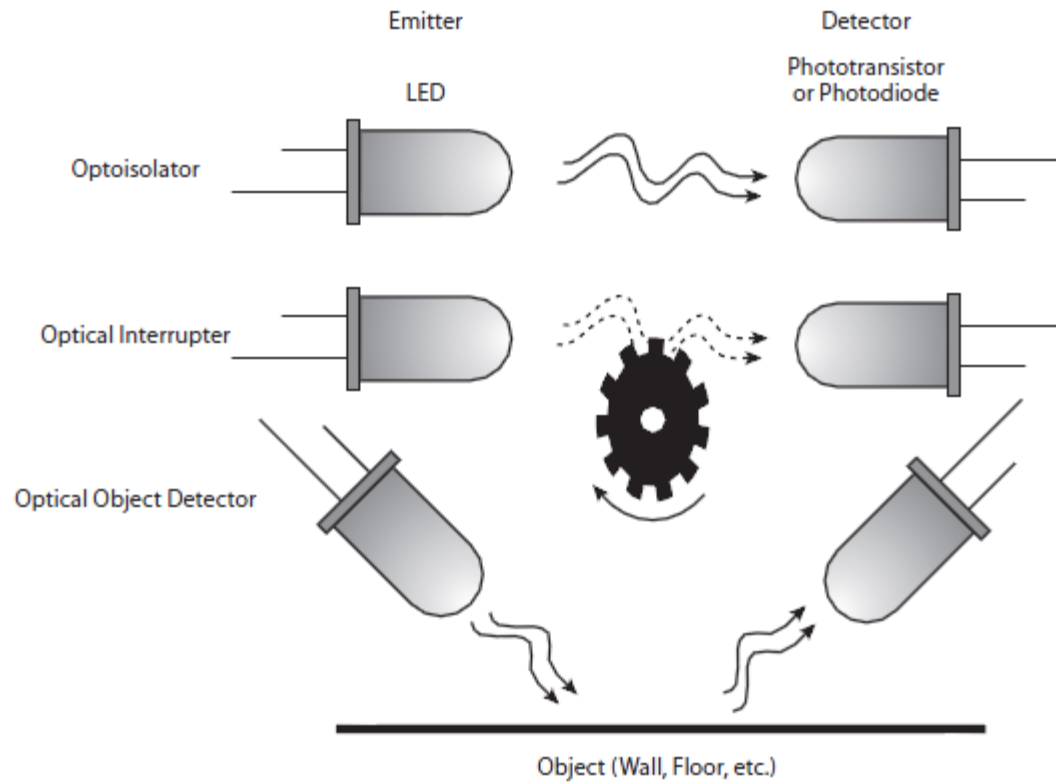

base

bumper

odometry

wall

cliff

- Micro switches:

buttons

wheels

- Capacitive sensor:

dirt

Power supply

- Measuring power supply
 - capacitance of the accumulator [mAh]
 - voltage [V]
 - current [A]
 - temperature

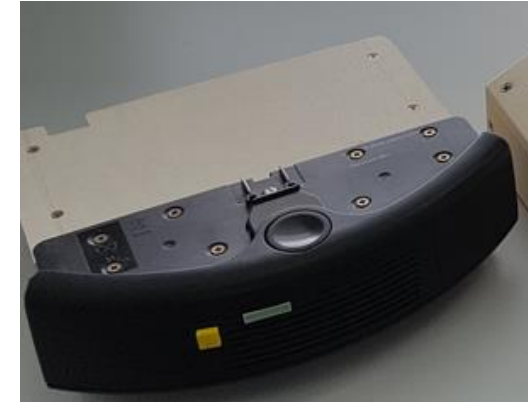

Indicators

- Led lights
 - Status (green, red)
 - Dirt detection (blue)
- Speaker
 - piezoelectric beeper

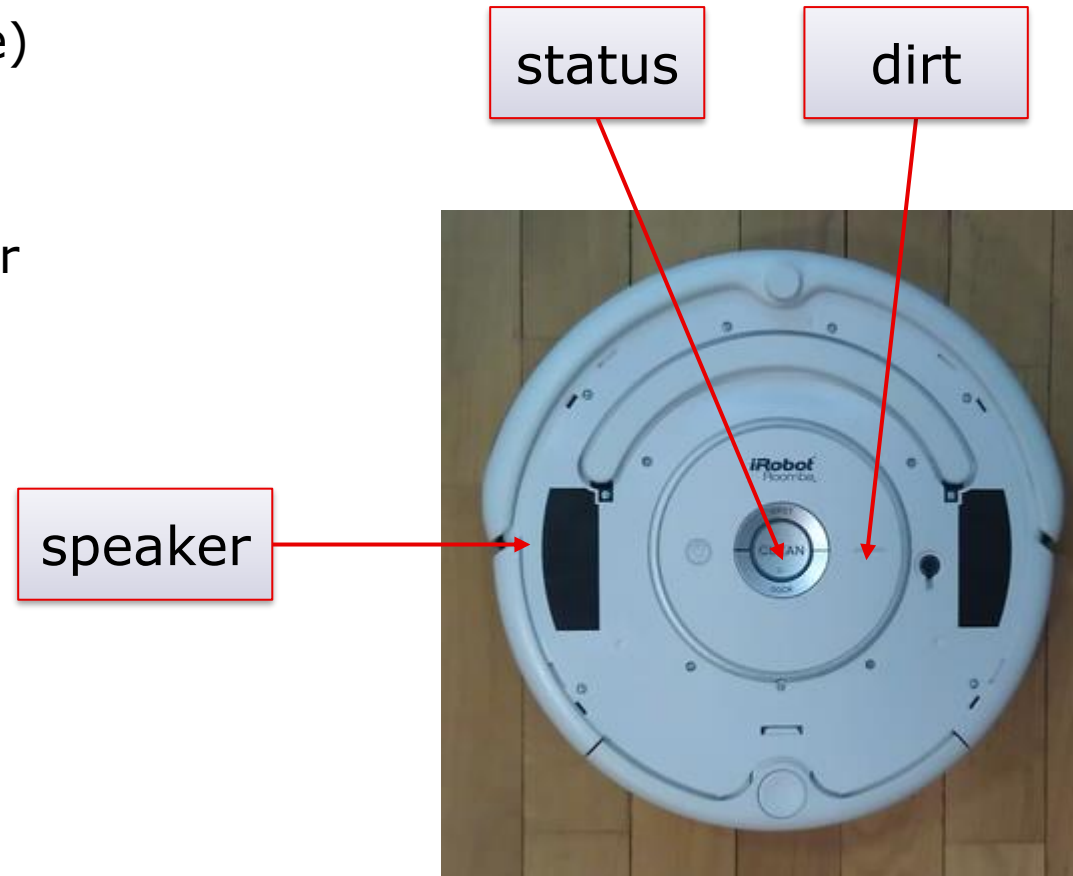

RGBD sensor Kinect

- PrimeSense sensor

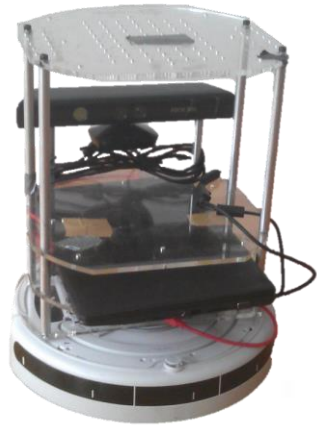

Components

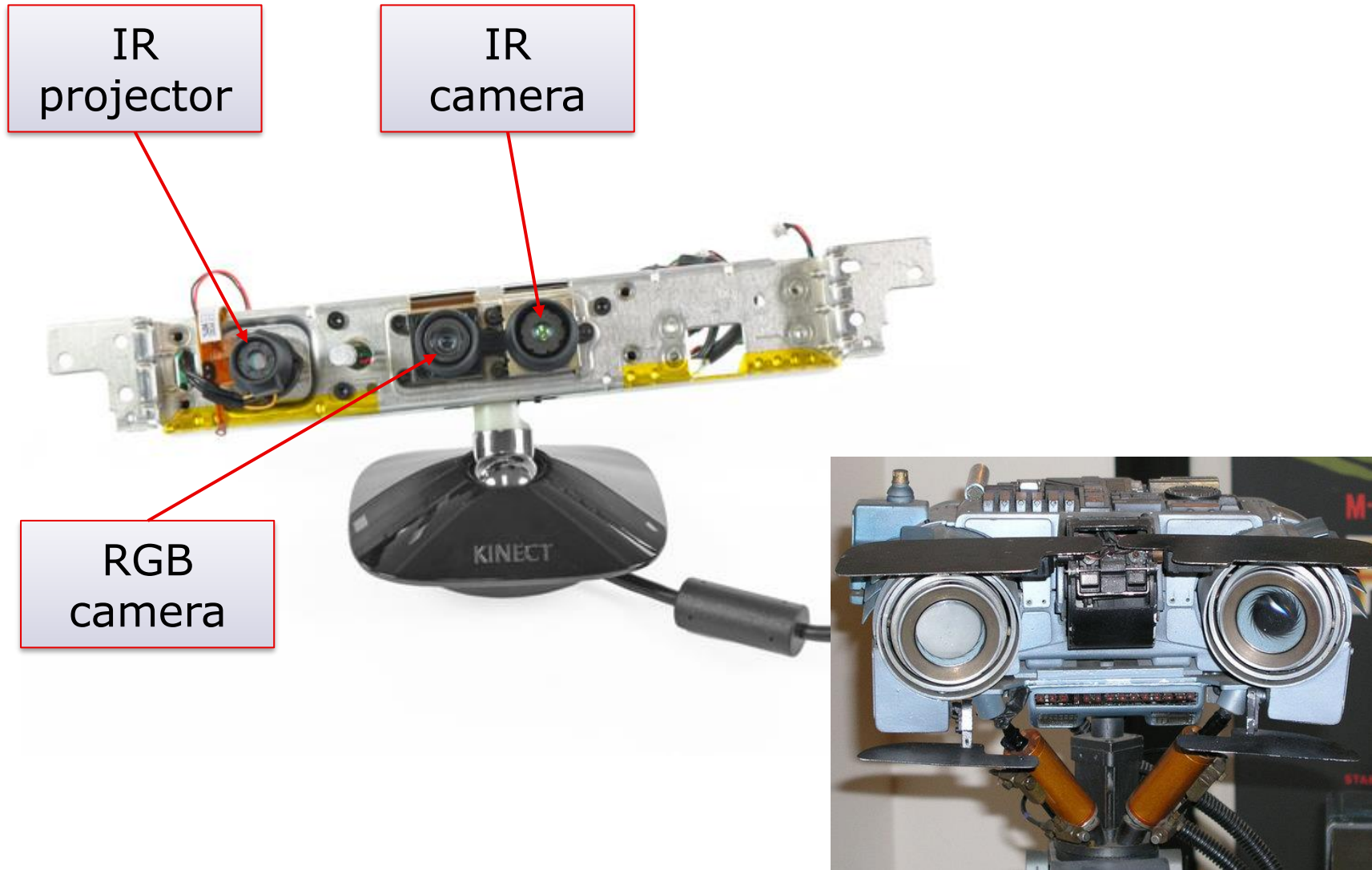

Scheme

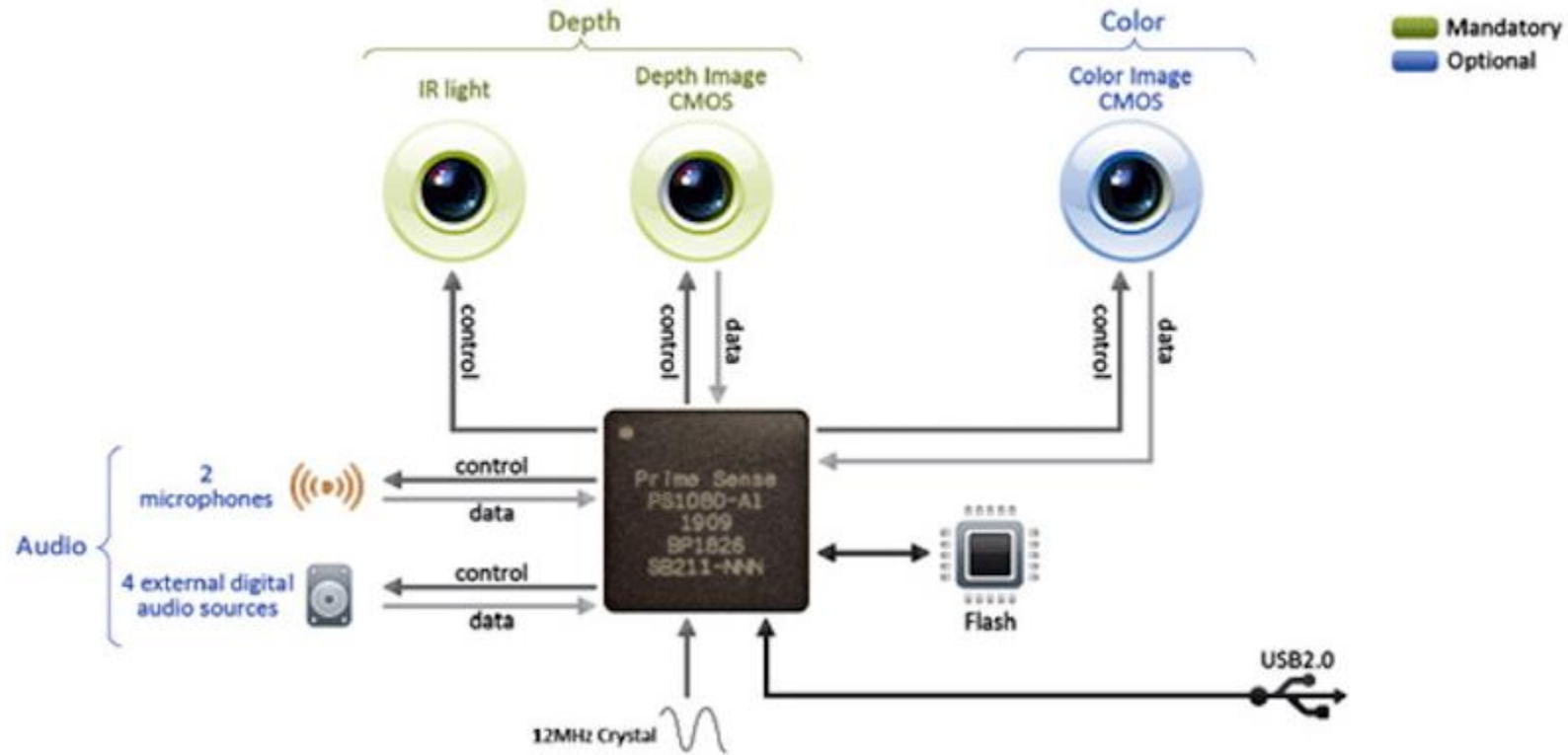

Projected pattern

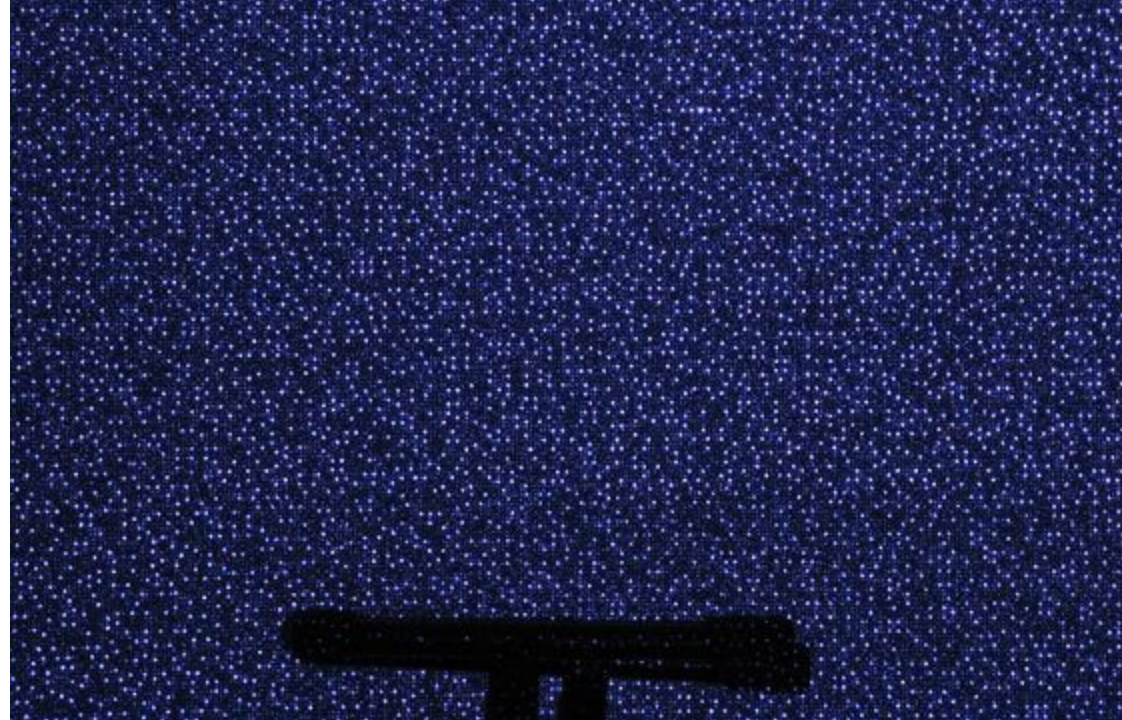

Projected pattern

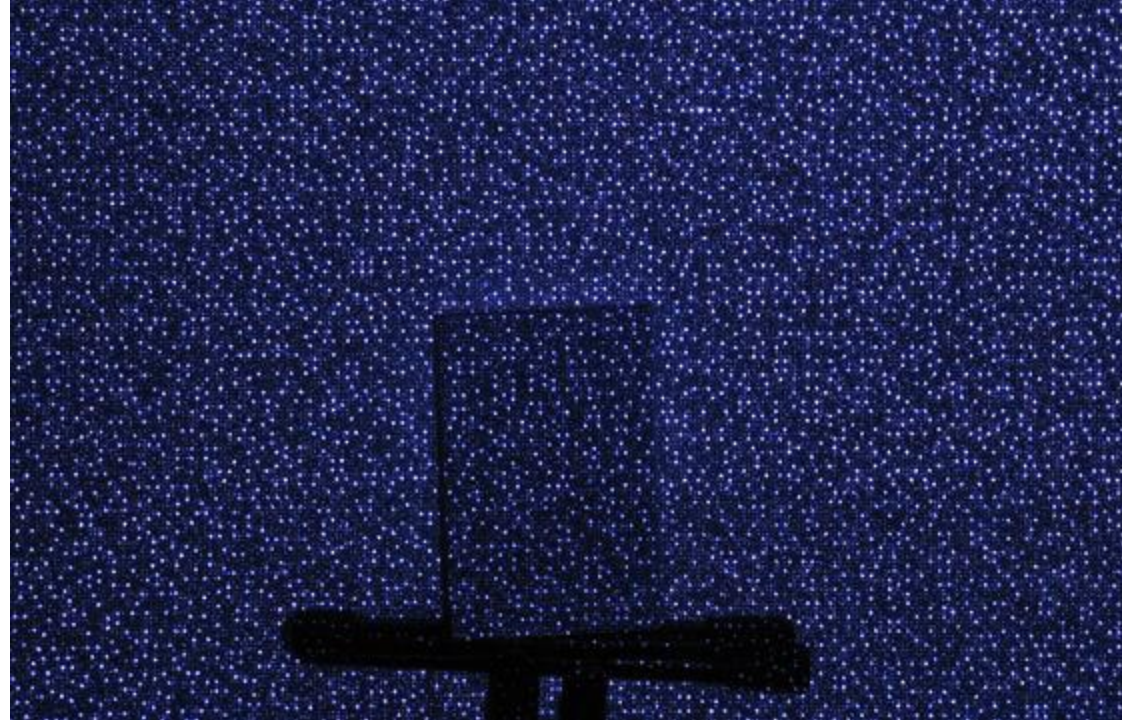

Patent No.: US 7,433,024 B2

**RANGE MAPPING USING SPECKLE
DECORRELATION**

(57)

ABSTRACT

A method for mapping includes projecting a primary speckle pattern from an illumination assembly into a target region. A plurality of reference images of the primary speckle pattern are captured at different, respective distances from the illumination assembly in the target region. A test image of the primary speckle pattern that is projected onto a surface of an object in the target region is captured and compared to the reference images so as to identify a reference image in which the primary speckle pattern most closely matches the primary speckle pattern in the test image. The location of the object is estimated based on a distance of the identified reference image from the illumination assembly.

Patent

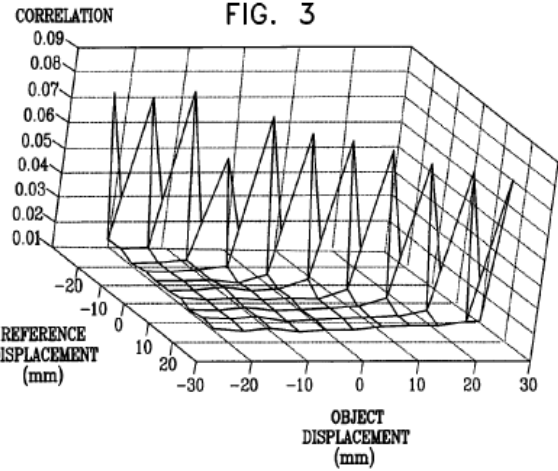
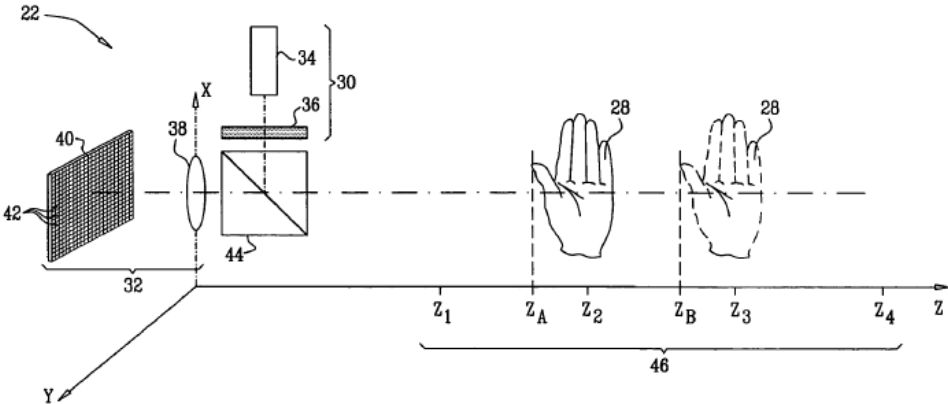
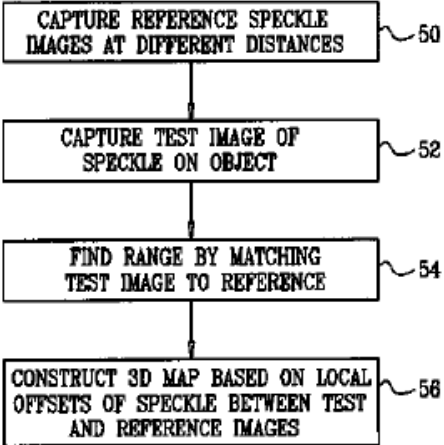
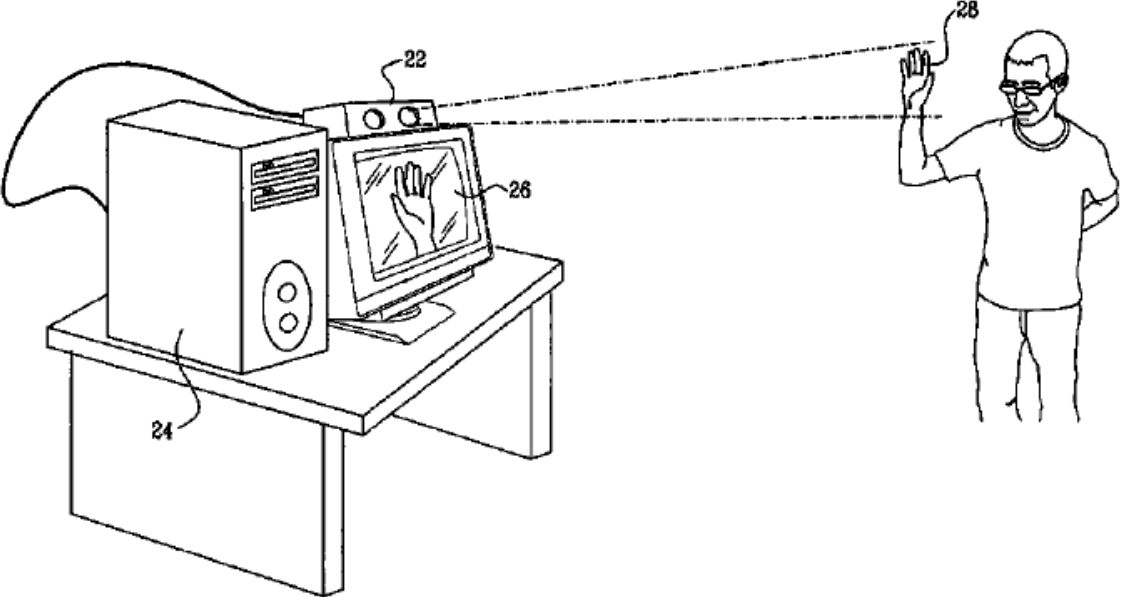

Kinect performance

- Specifications:
 - Horizontal field of view: 57 degrees
 - Vertical field of view: 43 degrees
 - Physical tilt range: ± 27 degrees
 - Depth sensor range: 1.2m - 3.5m
 - 320x240 16-bit depth @ 30 frames/sec
 - 640x480 32-bit colour @ 30 frames/sec
 - 16-bit audio @ 16 kHz

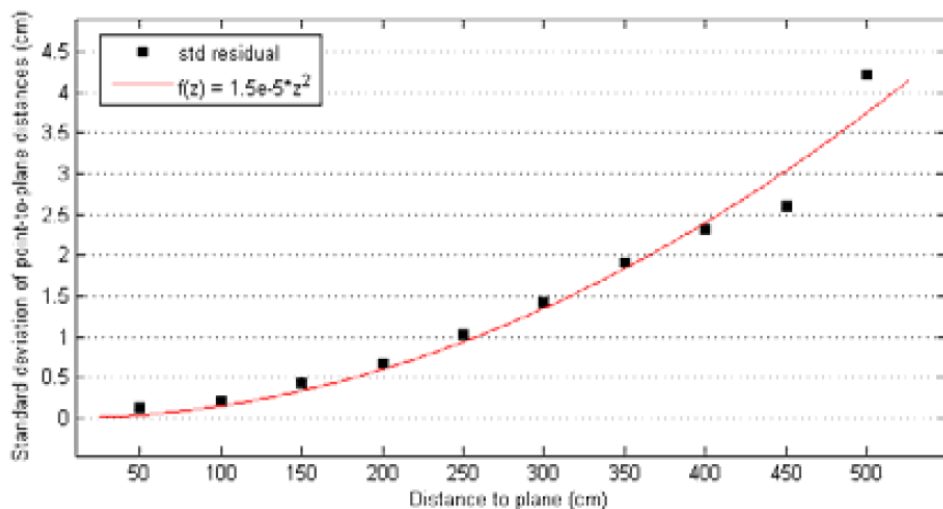

Khoshelham, 2011

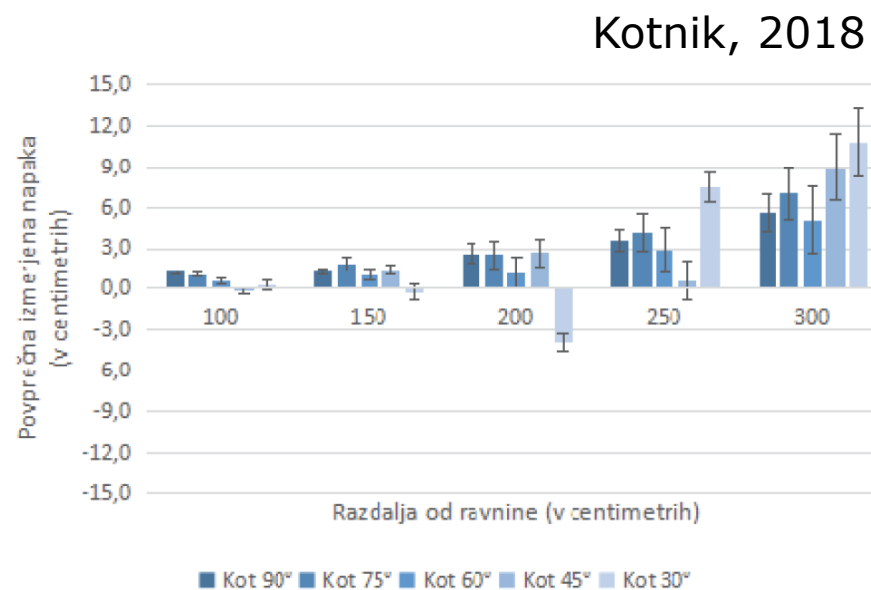

RGBD information

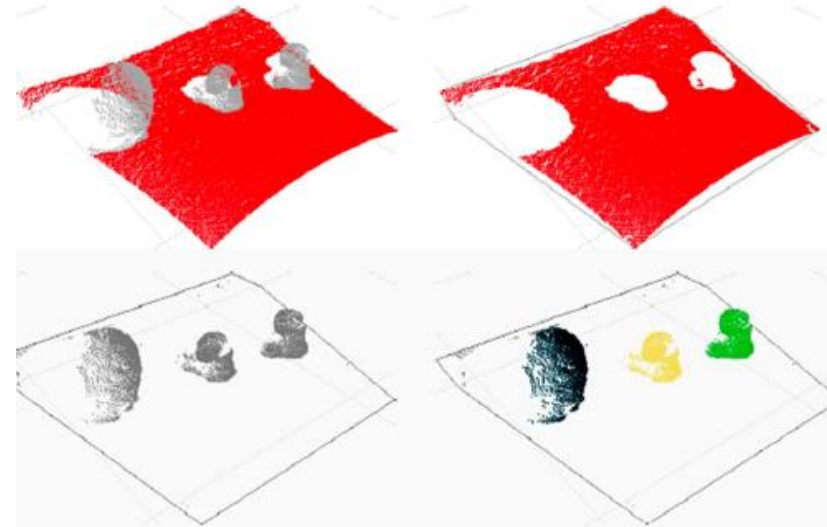
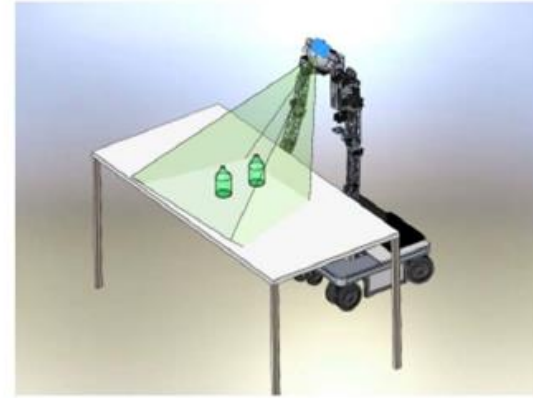

TurtleBot in simulation

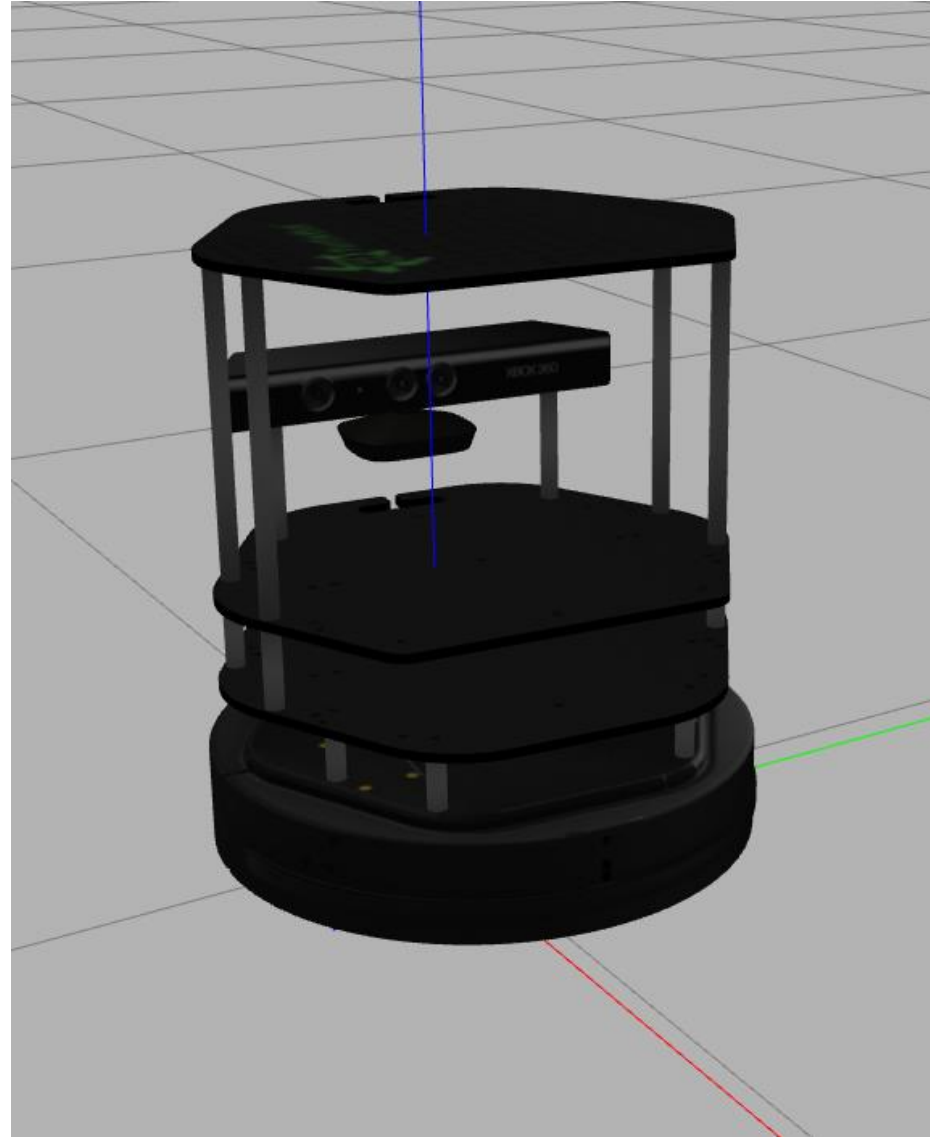

Gazebo and RViz

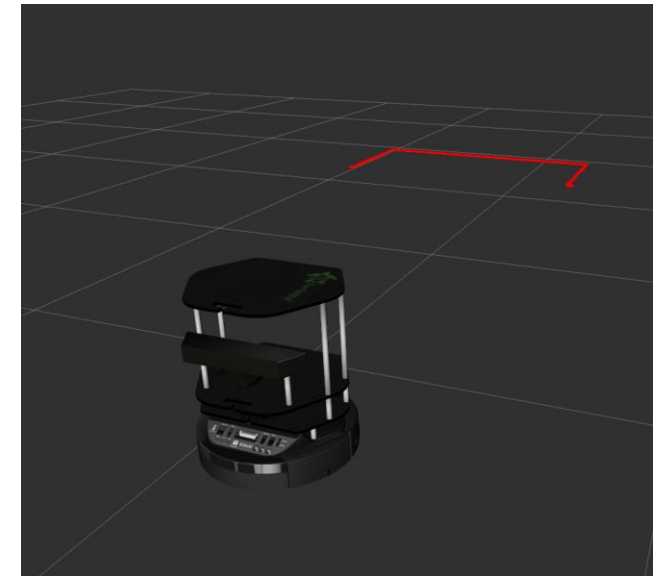
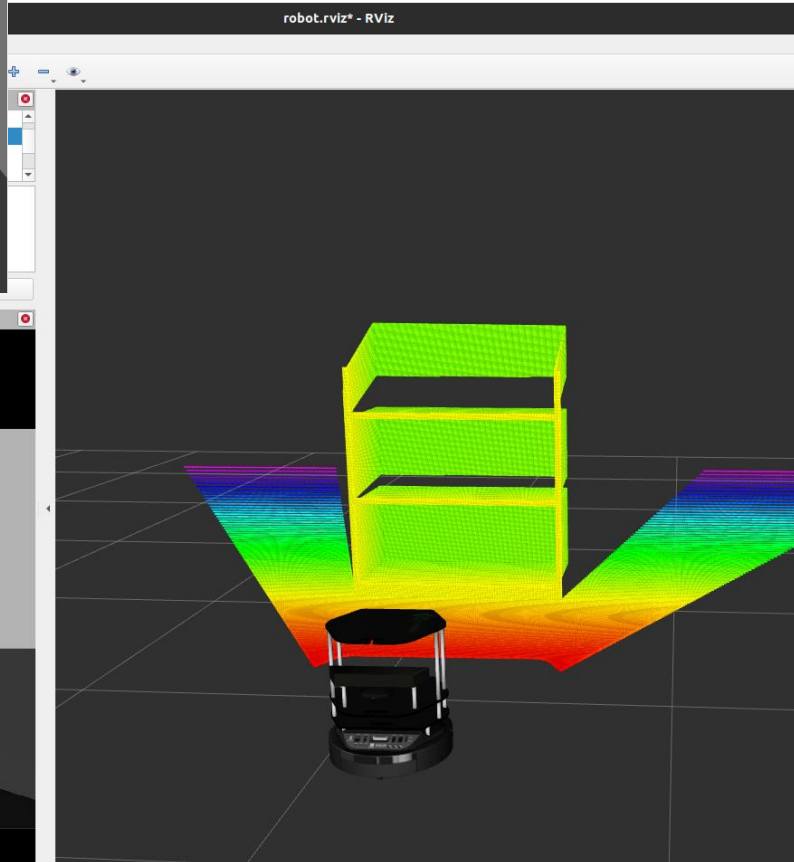
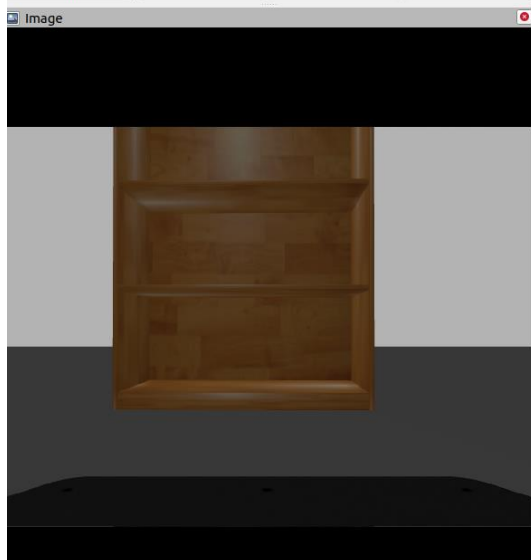
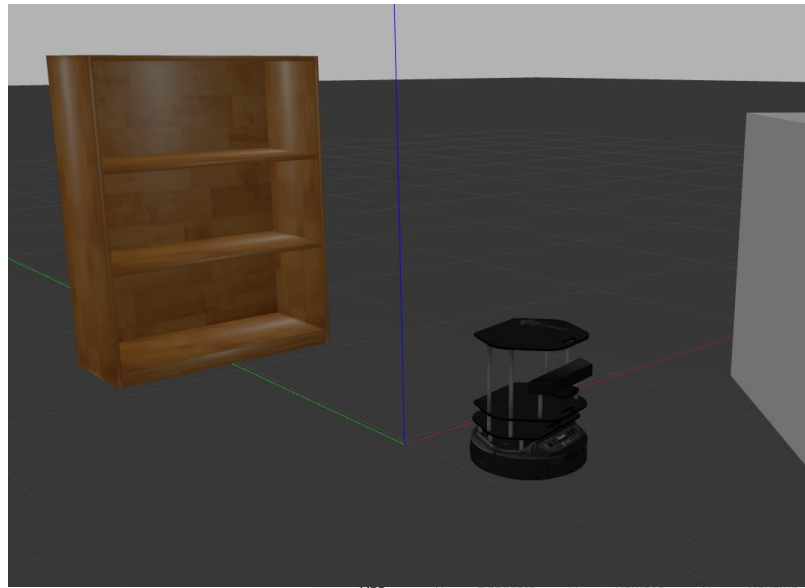

Literature

- Dr. John (Jizhong) Xiao, City College of New York, Robot Sensing and Sensors
- Tod E. Kurt, Hacking Roomba: ExtremeTech, Wiley, 2006
- <http://www.ifixit.com/Teardown/Microsoft-Kinect-Teardown/4066/3>
- Futurepicture, <http://www.futurepicture.org/?p=116>
- United States Patent, Garcia et. al, Patent No. 7,433,024 B2
- Peter Corke, Robotics, Vision and Control, 2017
- other