

MAGNETIZEM

- magnetit poznan že starim Grkom (Tales, 600 pr.n.š.)
Kitajcem (400 pr.n.š.): privlači železo
- kompas (Kitajska, 12. stoletje)
- Ørsted (1820): tok v žici ima enak učinek na magnetno iglo kot trajni magnet
- Faraday: pojem magnetnega polja, silnic; indukcija (1831)
- Gauss, Biot, Savart, Ampère: zveza med električnim in magnetnim poljem
- Maxwell: klasična teorija elektromagnetizma
- Tesla: večfazni motor na izmenični tok, transformator
- Einstein: posebna teorija relativnosti

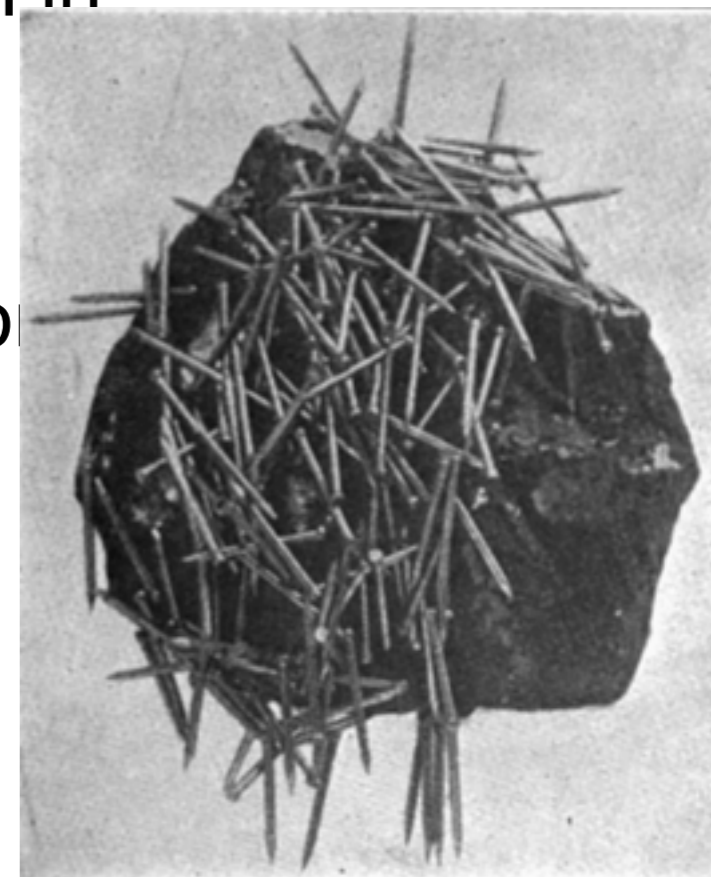

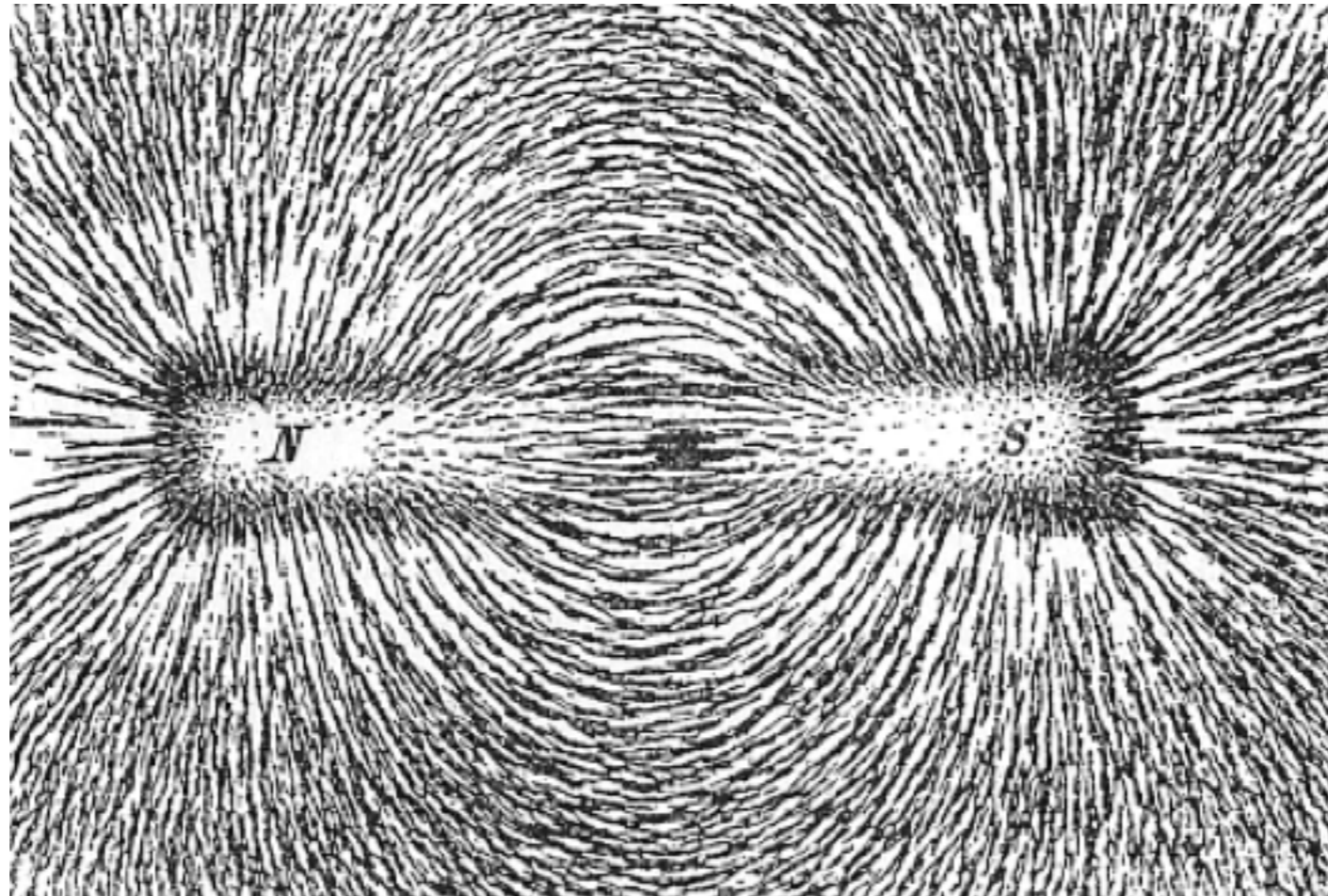

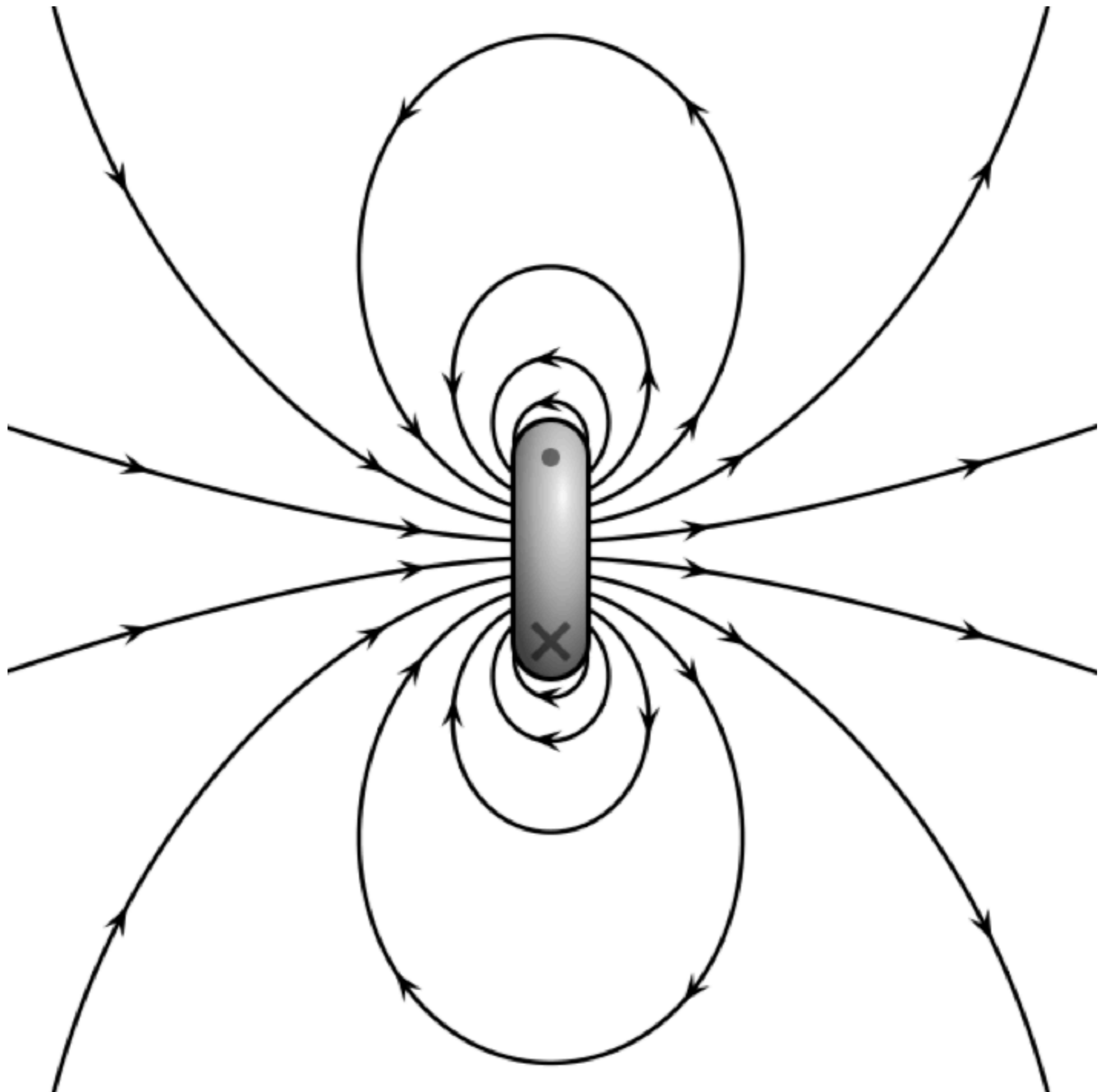

US/UK World Magnetic Model -- Epoch 2010.0

Main Field Inclination (I)

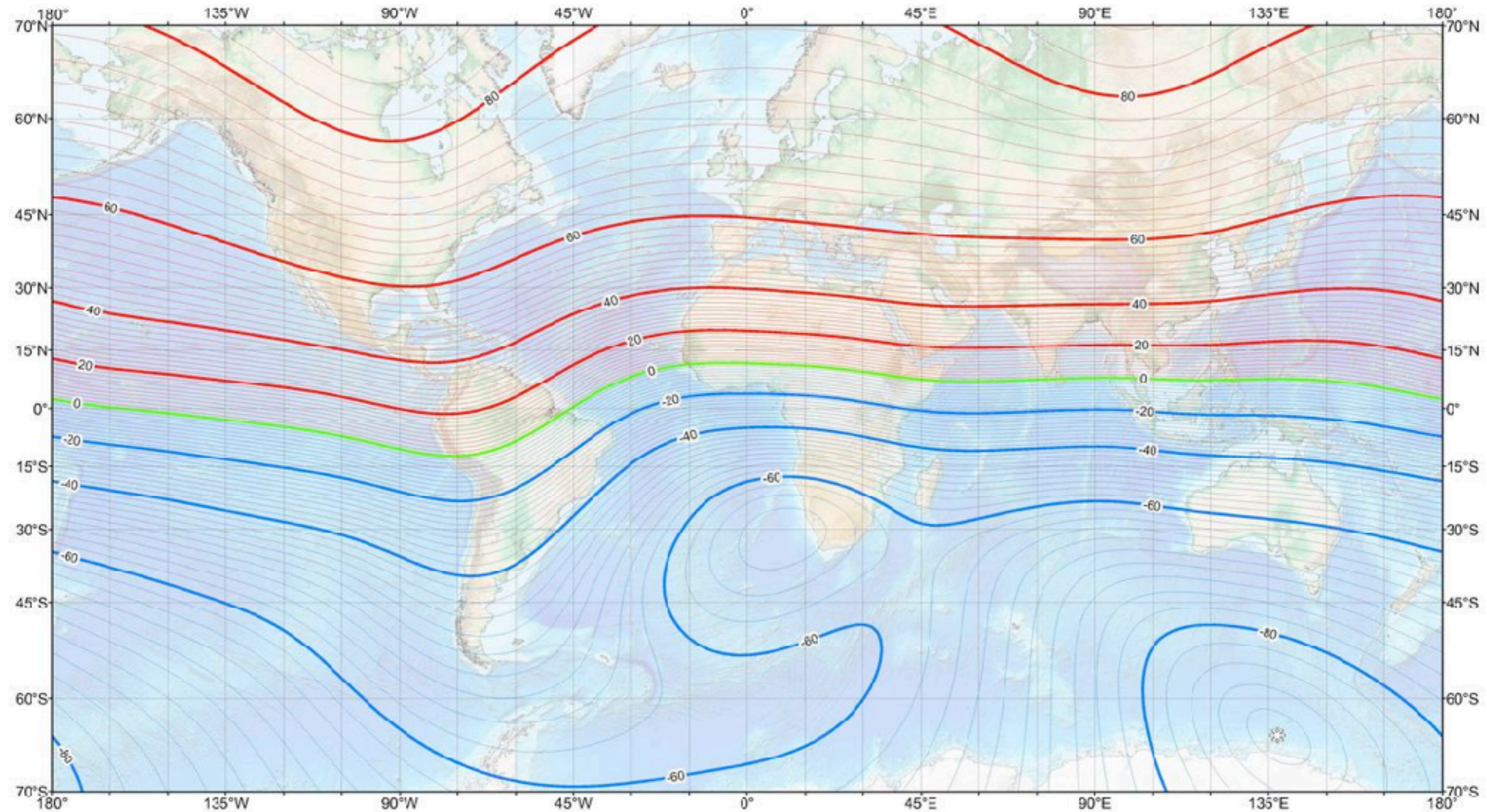

Main field inclination (I)
Contour interval: 2 degrees, red contours positive (down); blue negative (up); green zero line.
Mercator Projection.
☼ : Position of dip poles

Map developed by NOAA/NGDC & CIGES
<http://ngdc.noaa.gov/geomag/WMM/>
Map reviewed by NGA/BGS
Published January 2010

US/UK World Magnetic Model -- Epoch 2010.0

Main Field Declination (D)

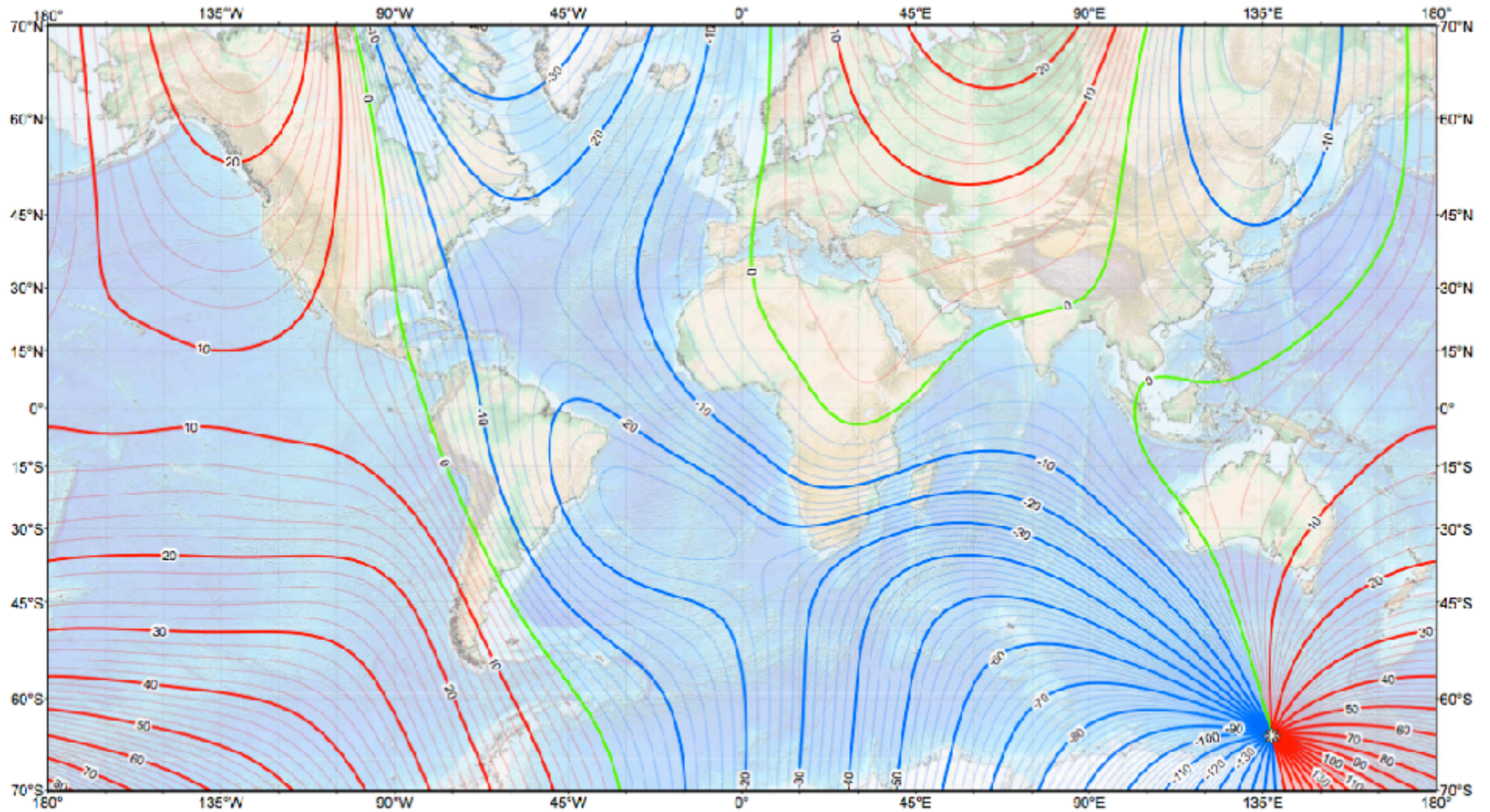

Main field declination (D)
Contour interval: 2 degrees, red contours positive (east); blue negative (west); green (agonic) zero line.
Mercator Projection.
★ : Position of dip poles

Map developed by NDA/NCGDC & CIGES
<http://ncdc.ncaa.gov/geomag/WMM/>
Map reviewed by NGA/BGS
Published January 2010

Magnetic Field Calculators

Declination

U.S. Historic Declination

Magnetic Field

Magnetic Field Component Grid

Magnetic Declination Estimated Value

Declination is calculated using the most recent [World Magnetic Model \(WMM\)](#) or the [International Geomagnetic Reference Field \(IGRF\)](#) model. For 1590 to 1900 the calculator is based on the [gufm1](#) model. A smooth transition from gufm1 to IGRF was imposed from 1890 to 1900. Declination results are typically accurate to 30 minutes of arc, but environmental factors can cause magnetic field disturbances. The calculator provides an easy way for you to get results in HTML, XML, or CSV programmatically (API). For more information click the information button above.

Calculate Declination

Latitude: S N

Longitude: W E

Model: WMM (2014-2019) IGRF (1590-2019)

Date: Year Month Day

Result format: HTML XML CSV PDF

Calculate

Lookup Latitude / Longitude

Either enter a zip code, select a country/city, or [search for an address at USGS Earth Explorer](#).

U.S. Zip Code:

- OR -

Country:

City:

Get & Add Lat / Lon

Declination

Model Used:	WMM2015
Latitude:	46° 4' 6" N i
Longitude:	14° 38' 23" E

Date	Declination
2016-06-03	3° 31' E ± 0° 21' changing by 0° 7' E per year

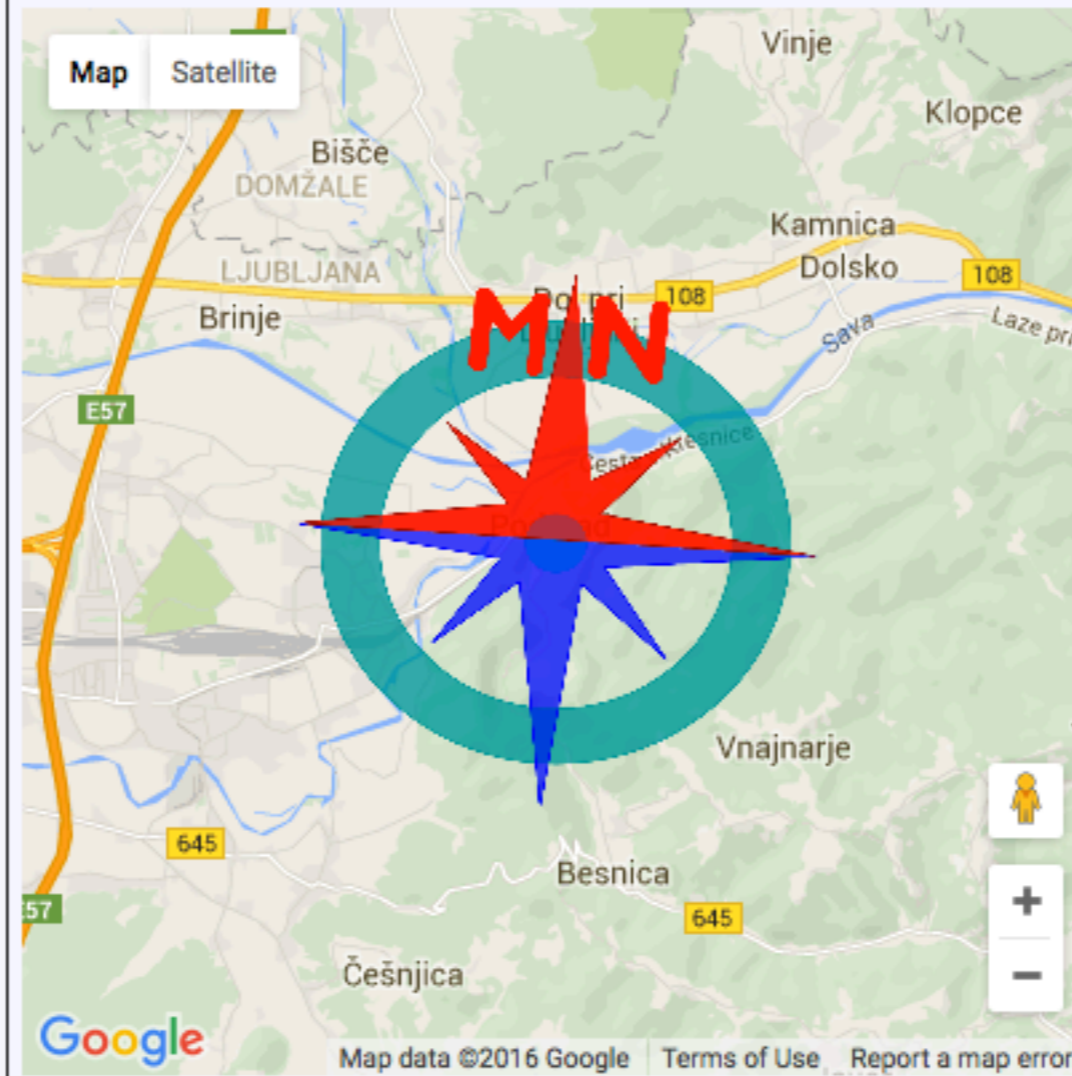

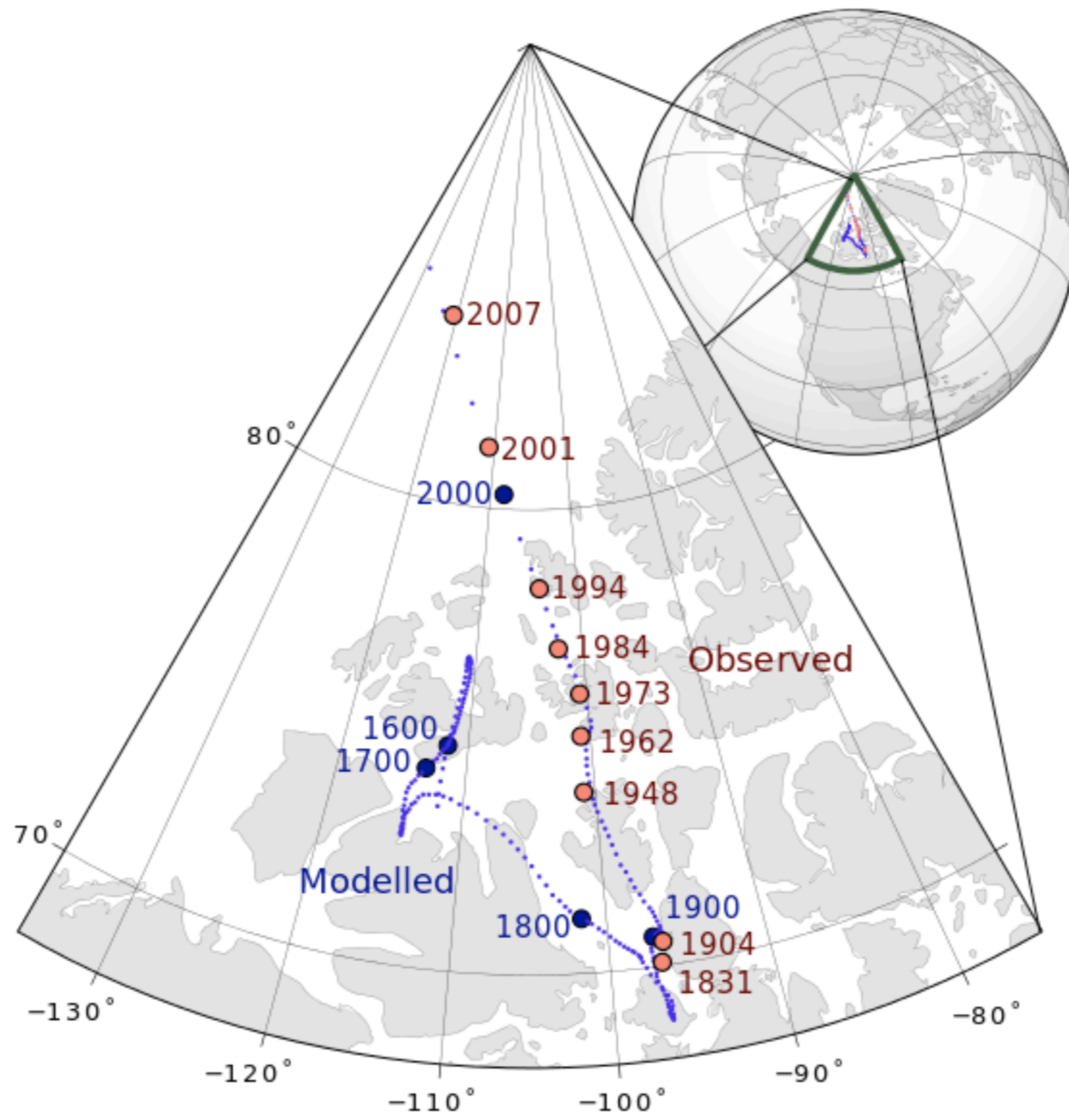

	LTO-1	LTO-2	LTO-3	LTO-4	LTO-5	LTO-6	LTO-7	LTO-8	Type M-8 ^[Note 1]	LTO-9	LTO-10	LTO-11	LTO-12	
Release date	2000 ^[8]	2003	2005	2007	2010 ^[9]	Dec. 2012 ^[10]	Dec. 2015 ^[11] ^{[12][13]}	Dec. 2017		<i>TBA</i>	<i>TBA</i>	<i>TBA</i>	<i>TBA</i>	
Native/raw data capacity	100 GB	200 GB	400 GB	800 GB	1.5 TB ^[14]	2.5 TB ^[15]	6.0 TB ^{[13][16]}	12 TB ^[17]	9 TB	24 TB ^{[14],[18]}	48 TB ^[14]	96 TB ^[14]	192 TB ^[14]	
Compressed capacity	200 GB	400 GB	800 GB	1.6 TB	3.0 TB	6.25 TB	15 TB	30 TB	22.5 TB	60 TB	112.5 TB	240 TB	480 TB	
Max uncompressed speed (MB/s) ^{[16][Note 2]}	20	40	80	120	140	160	300 ^[19]	360	300	<i>708</i>	<i>1,100</i>	<i>TBA</i>	<i>TBA</i>	
Max compressed speed (MB/s)	40	80	160	240	280	400	750	900	750	<i>1,770</i>	<i>2,750</i>	<i>TBA</i>	<i>TBA</i>	
Time to write a full tape at max uncompressed speed(hh:mm)	1:25	1:25	1:25	1:50	3:10	4:35	5:55	9:15	8:20	<i>TBA</i>	<i>TBA</i>	<i>TBA</i>	<i>TBA</i>	
Compression capable?	Yes, "2:1"					Yes, "2.5:1"				Planned, "2.5:1" ^{[18][20]}				
WORM capable?	No	Yes								No	Planned			
Encryption capable?	No	Yes										Planned		
Max. number of partitions	1 (no partitioning)				2	4						Planned		

I. Kaj je feromagnetizem?

T_c : Curiejeva temperatura ●

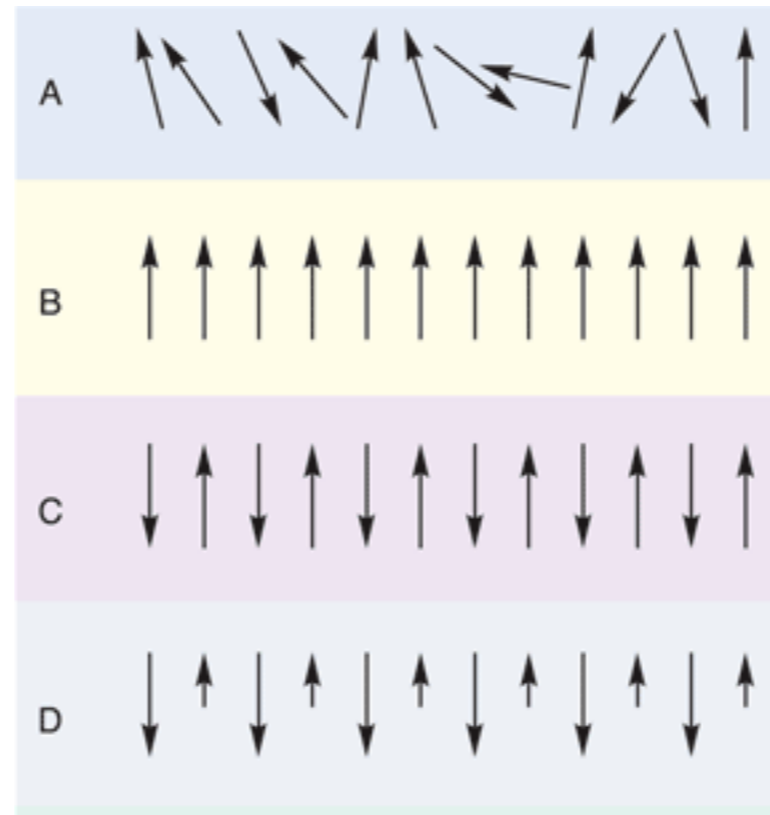

paramagnet

ferromagnet

antiferromagnet

ferimagnet

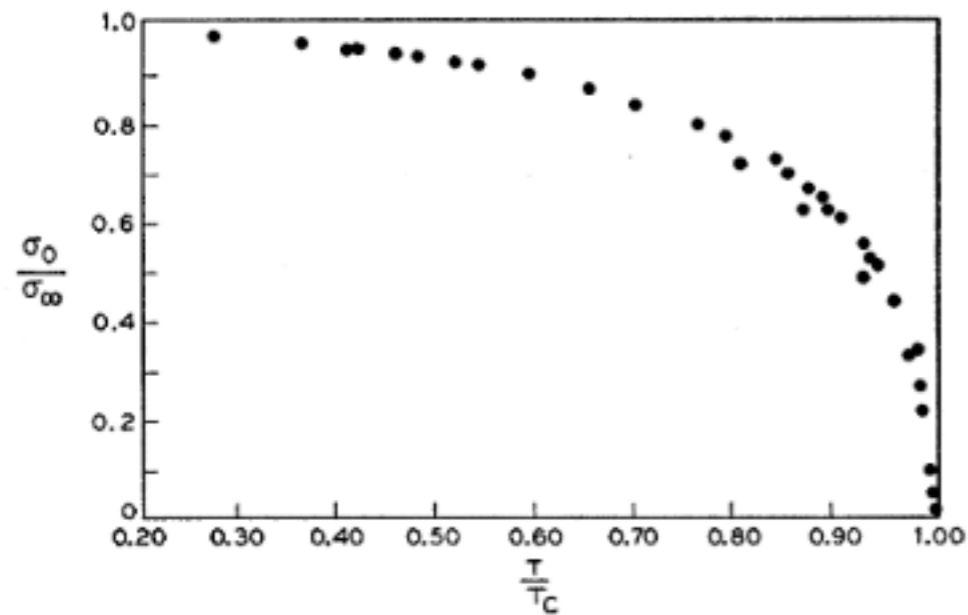
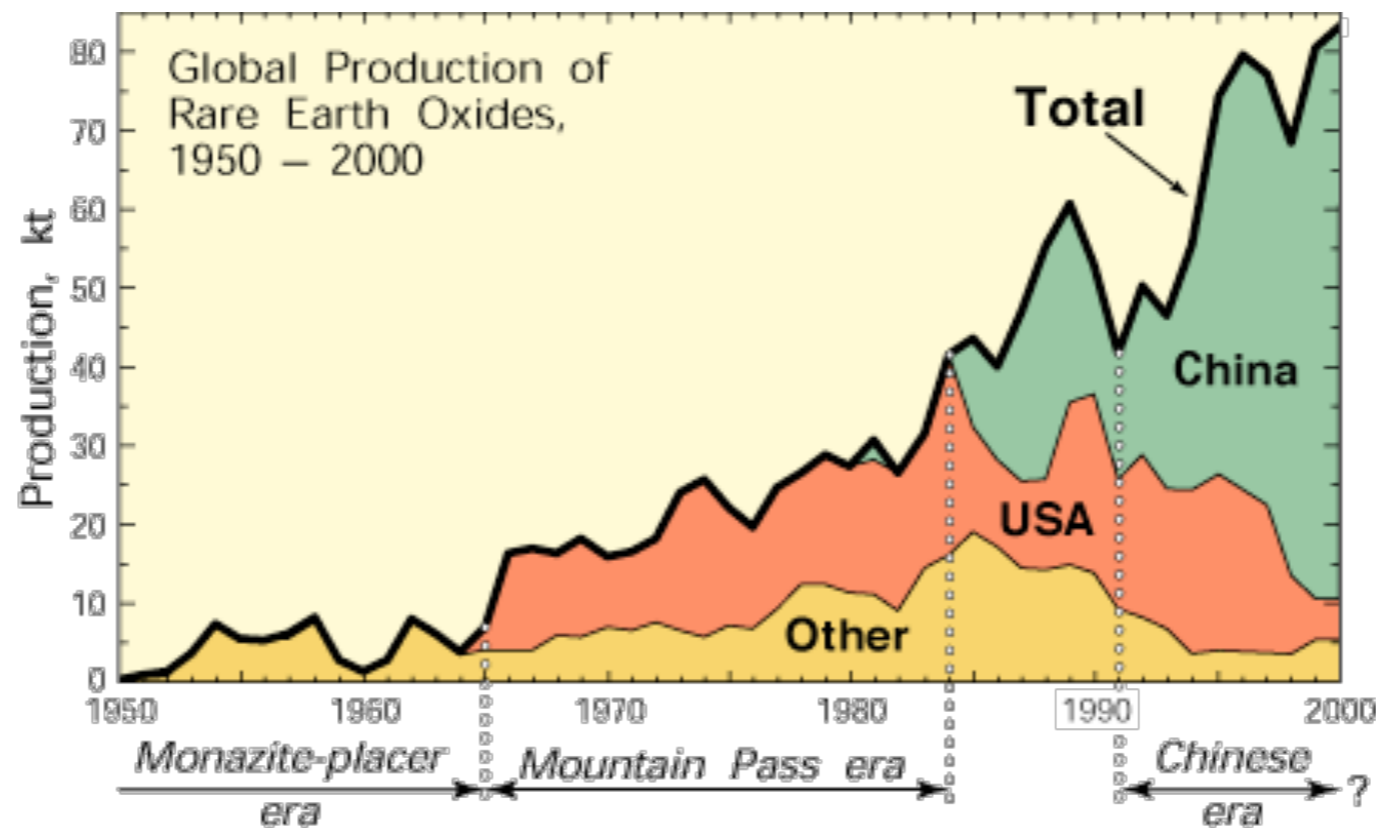

FIG. 3. Saturation magnetization of iron as a function of temperature. At room temperature the saturation value is 2.0 percent below that obtaining at zero degrees Kelvin.

Material	Curie temp. (K)
Co	1388
Fe	1043
Fe ₂ O ₃ ^[a]	948
FeOFe ₂ O ₃ ^[a]	858
NiOFe ₂ O ₃ ^[a]	858
CuOFe ₂ O ₃ ^[a]	728
MgOFe ₂ O ₃ ^[a]	713
MnBi	630
Ni	627
MnSb	587
MnOFe ₂ O ₃ ^[a]	573
Y ₃ Fe ₅ O ₁₂ ^[a]	560
CrO ₂	386
MnAs	318
Gd	292
Tb	219
Dy	88
EuO	69

REDKE ZEMLJE (=LANTANOIDI)



magnetne (Weissove) domene

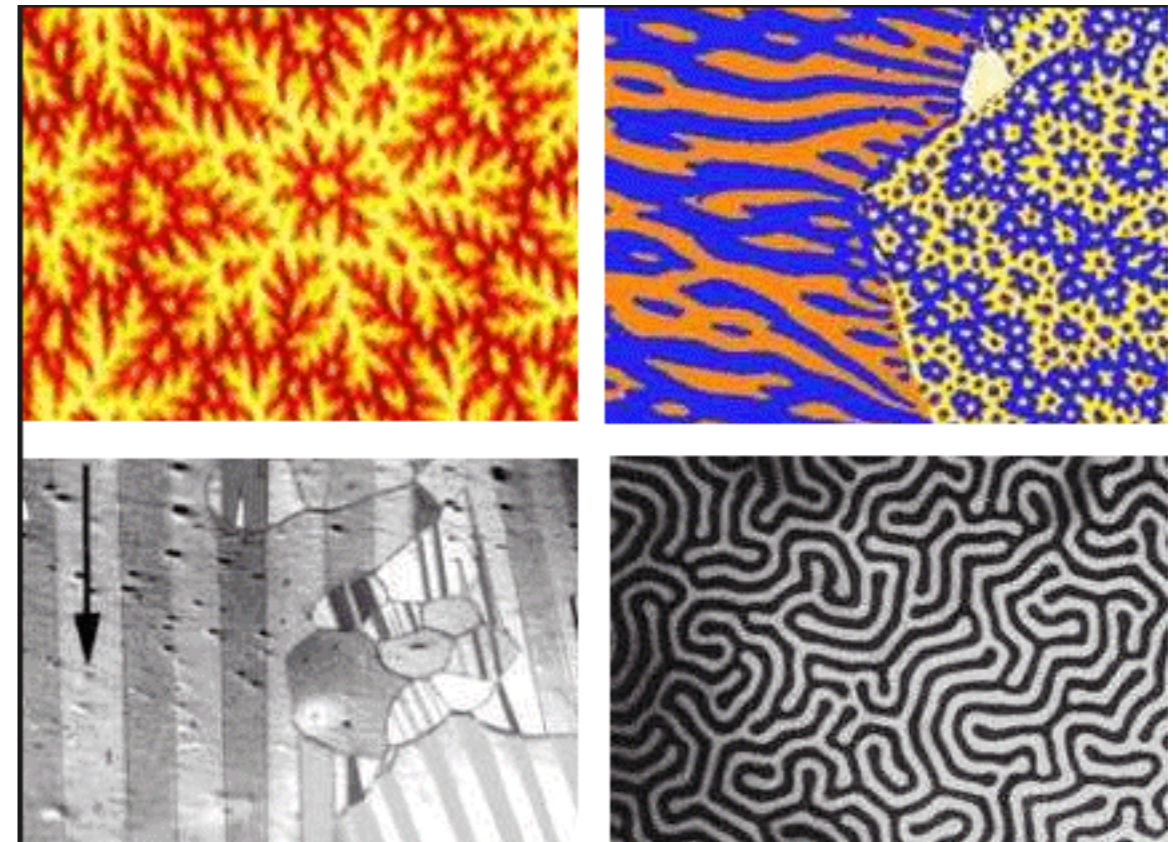
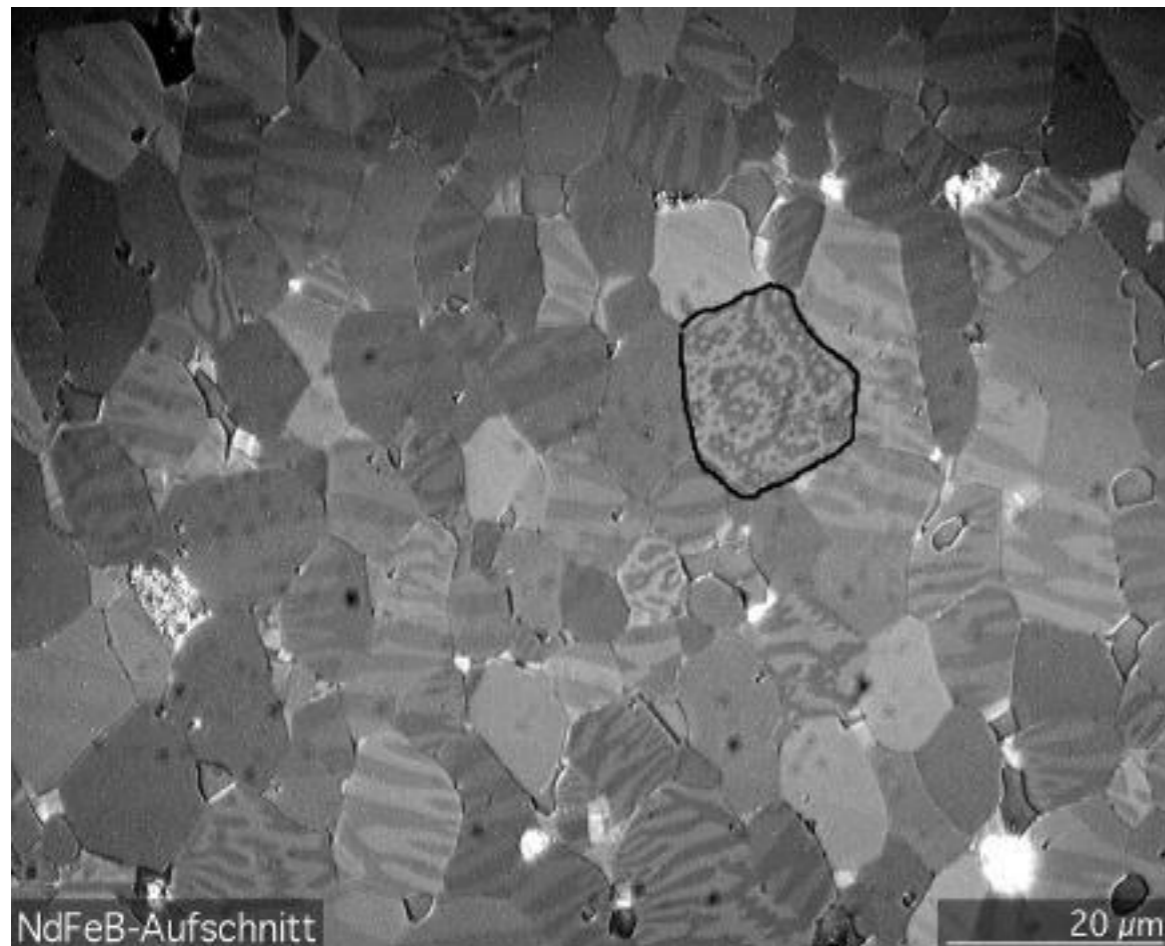
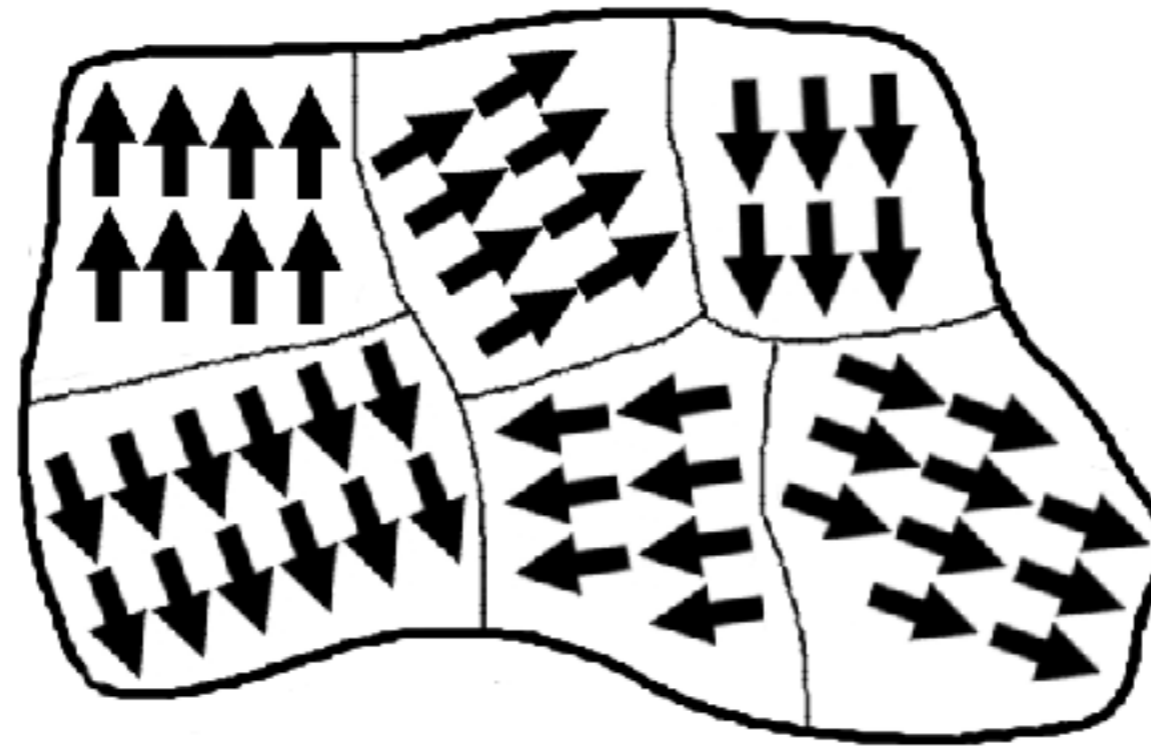

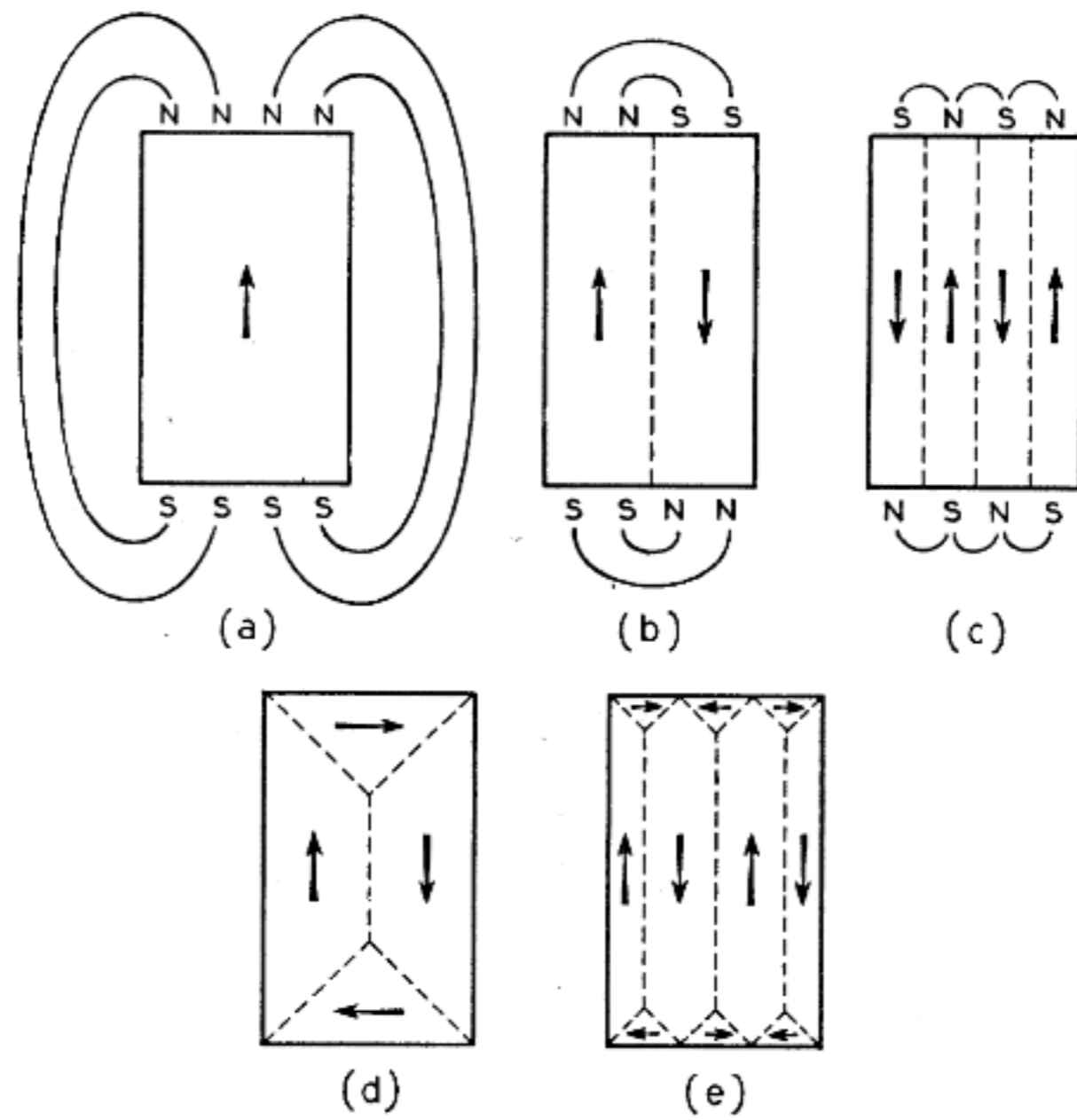
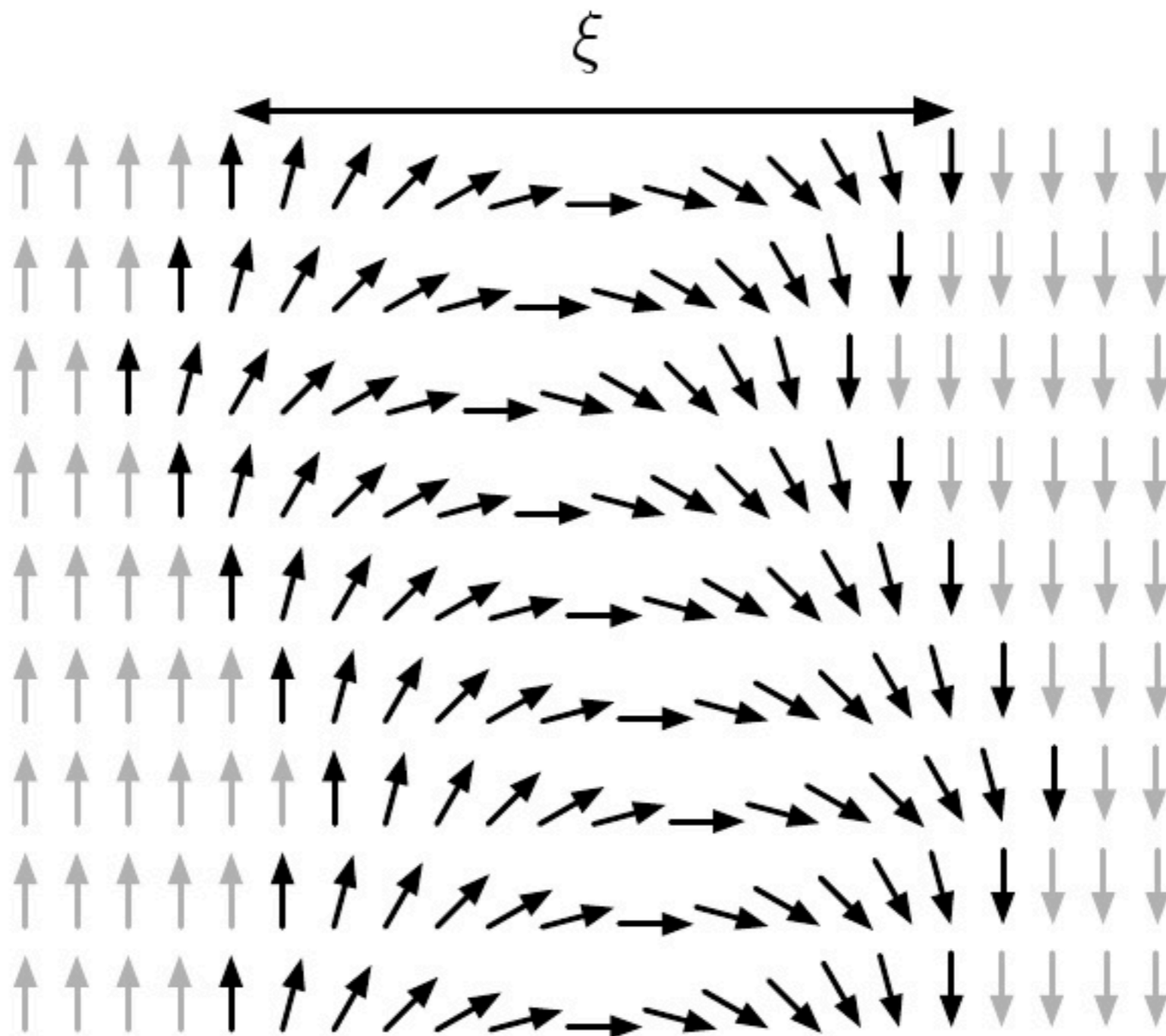
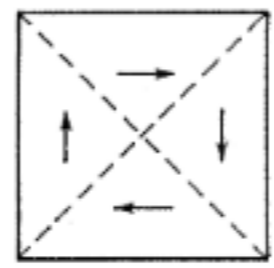
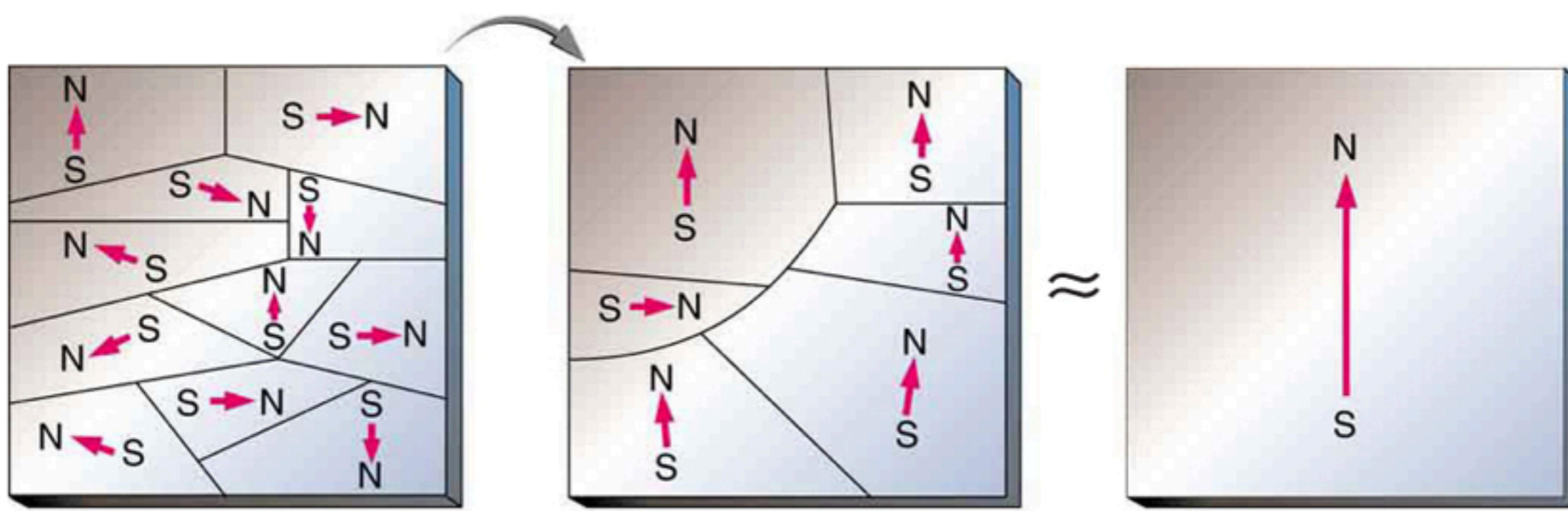

FIG. 9. The origin of domains.



domenska stena



UNMAGNETIZED

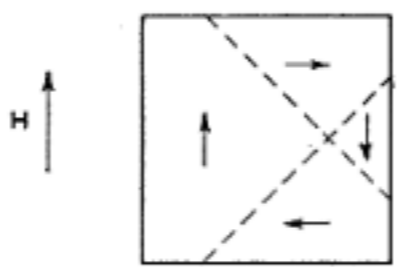

MAGNETIZED BY
DOMAIN GROWTH
(BOUNDARY DISPLACEMENT)

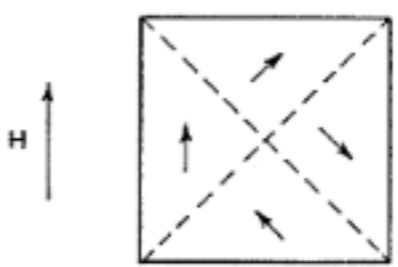

MAGNETIZED BY
DOMAIN ROTATION

FIG. 5. Funda-
mental magneti-
zation processes.

2a. Kaj je izmenjalna interakcija?

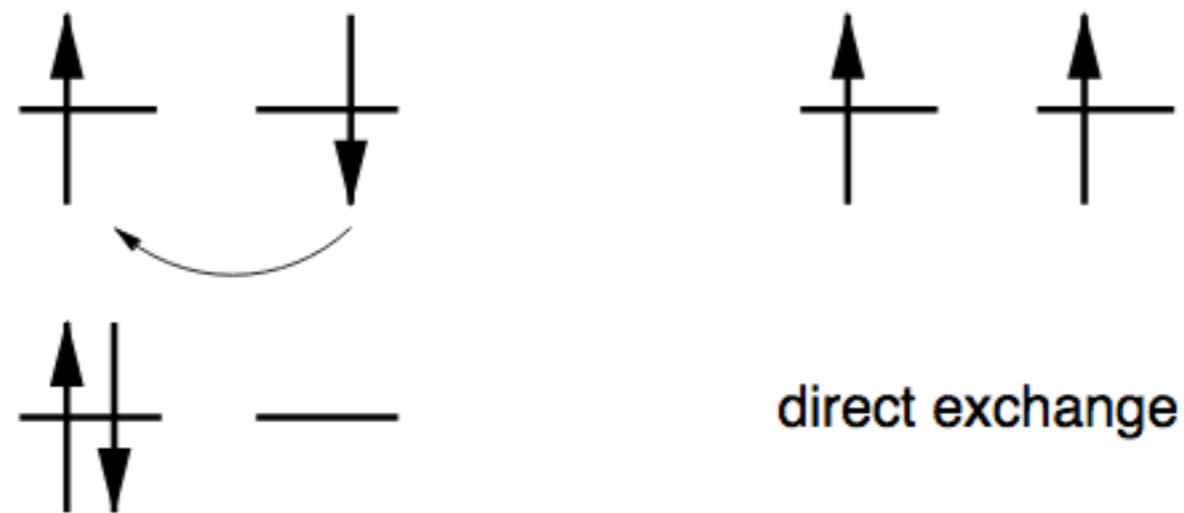
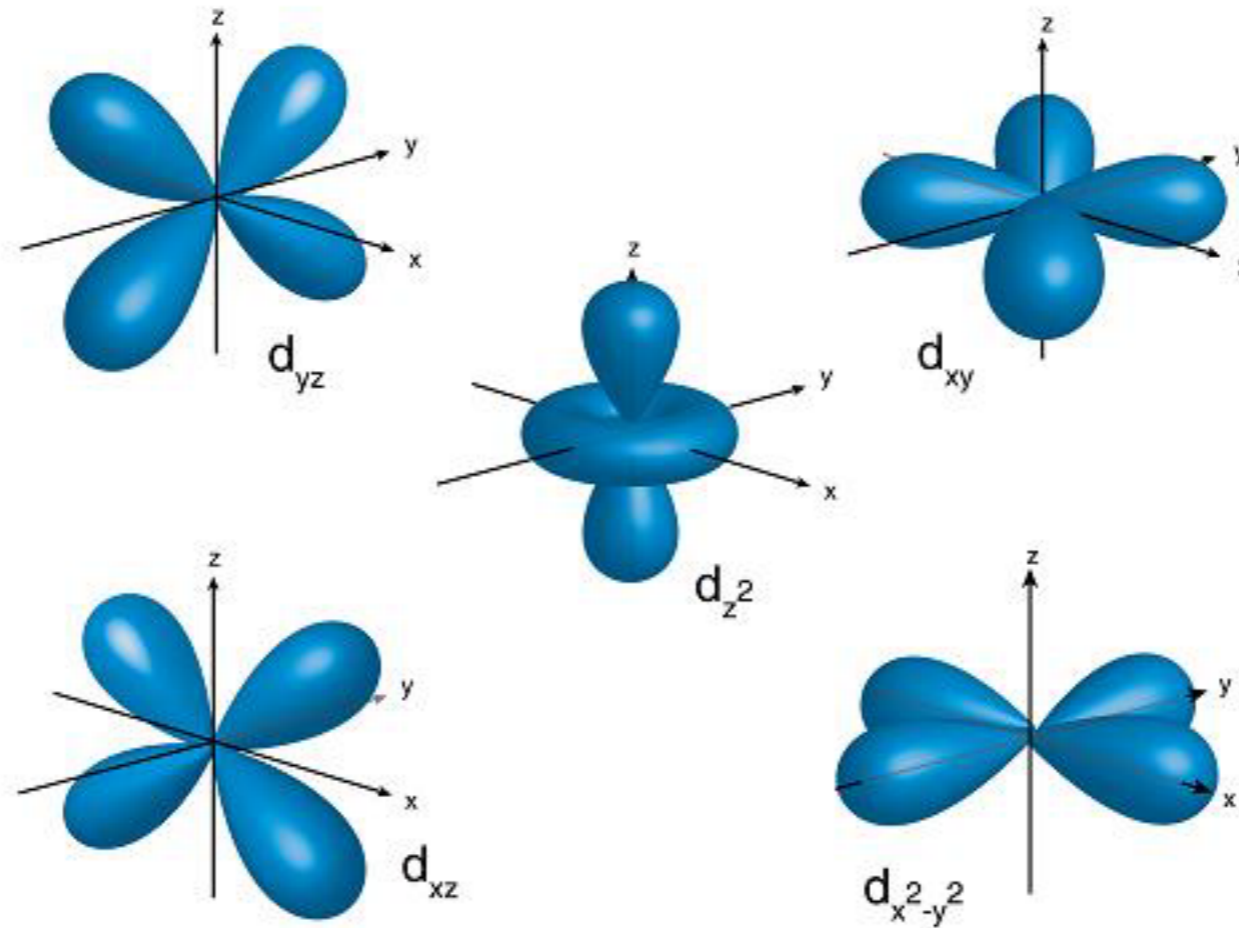

Fig. 3: *Simple picture of direct exchange: The antiparallel alignment of the spins (left) is favored, since it allows the electrons to hop to the neighboring site. For parallel spins (right) hopping is suppressed by the Pauli principle.*

2b. Kaj je magnetna anizotropija?



$$E = -K(\mathbf{M} \cdot \mathbf{n})^2$$

“Easy-axis”

3. Kaj je histerezna zanka? Kako jo lahko preprosto pojasnimo?

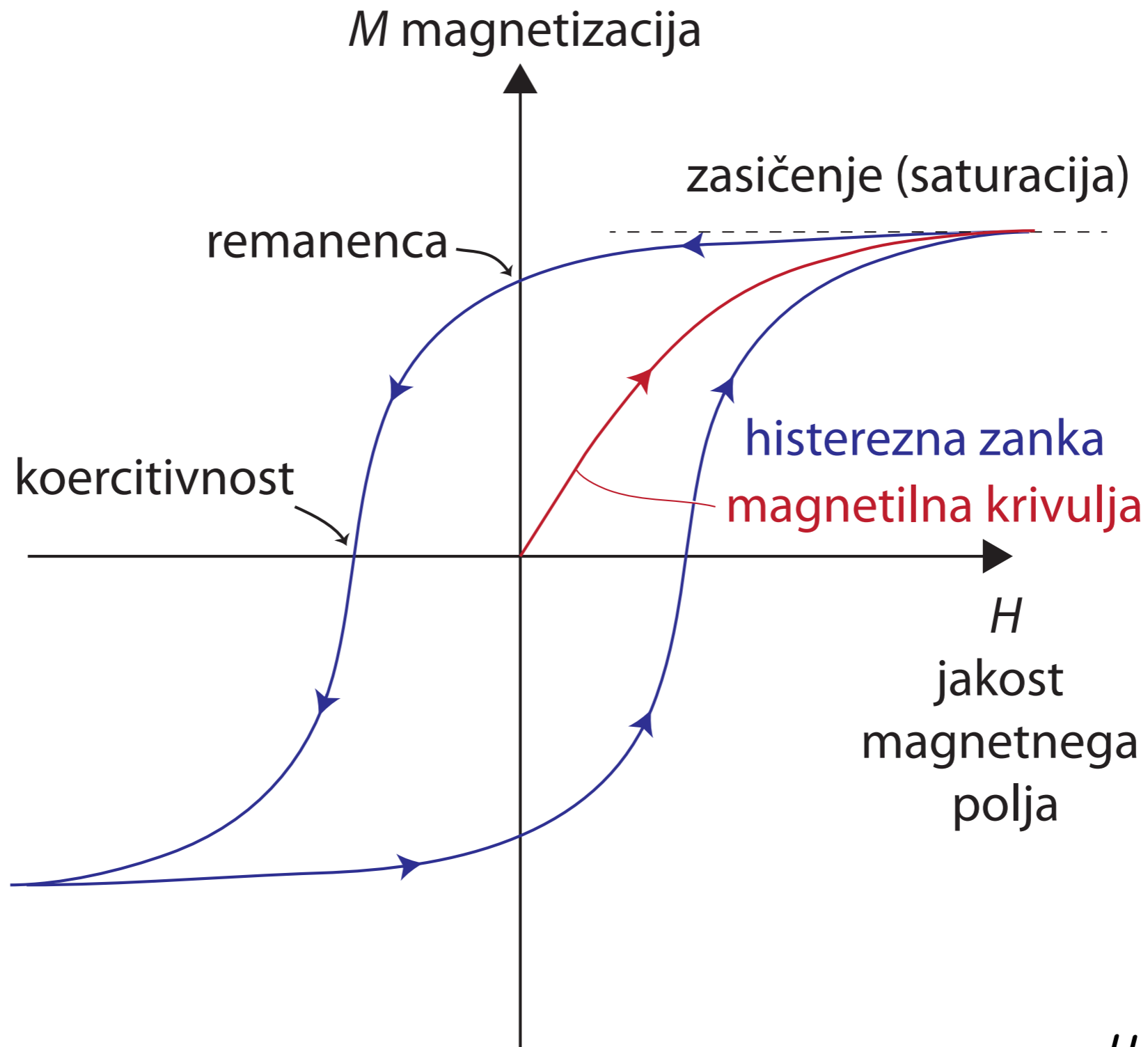

$$\mu \sim 1000$$

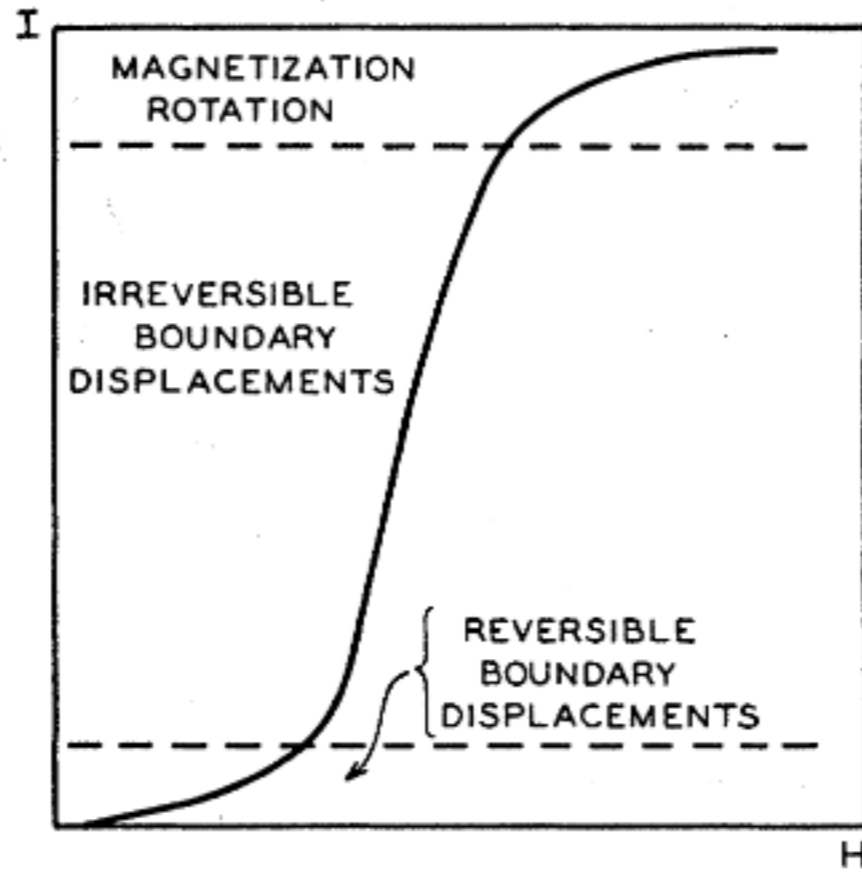

FIG. 6. Representative magnetization curve, showing the dominant magnetization processes in the different regions of the curve.

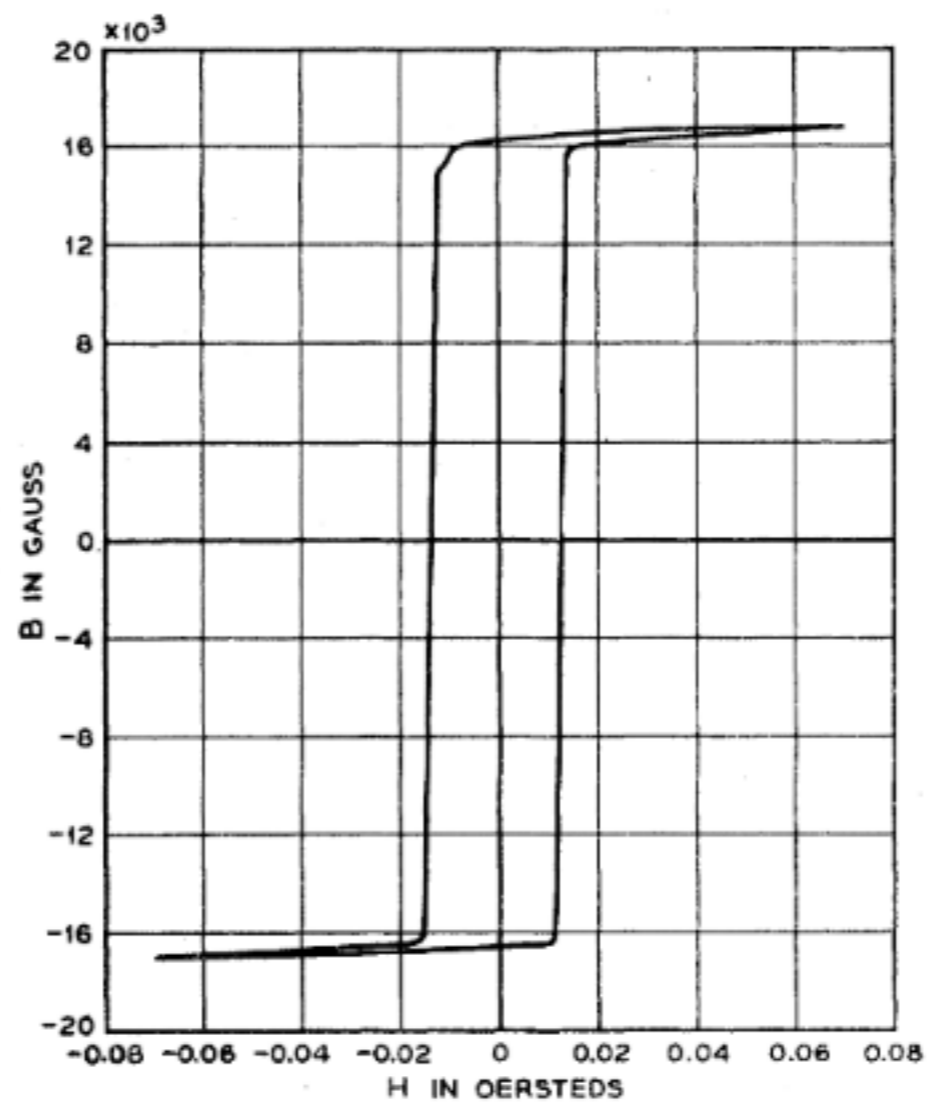
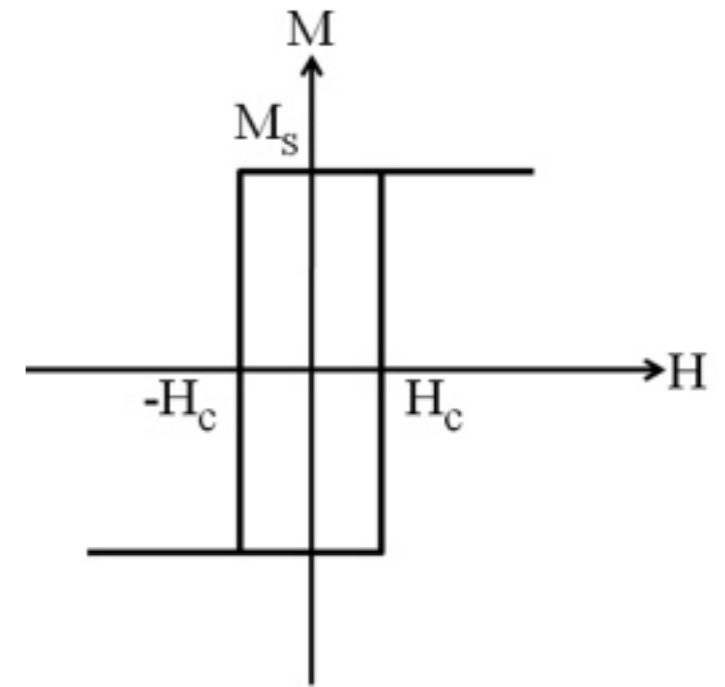
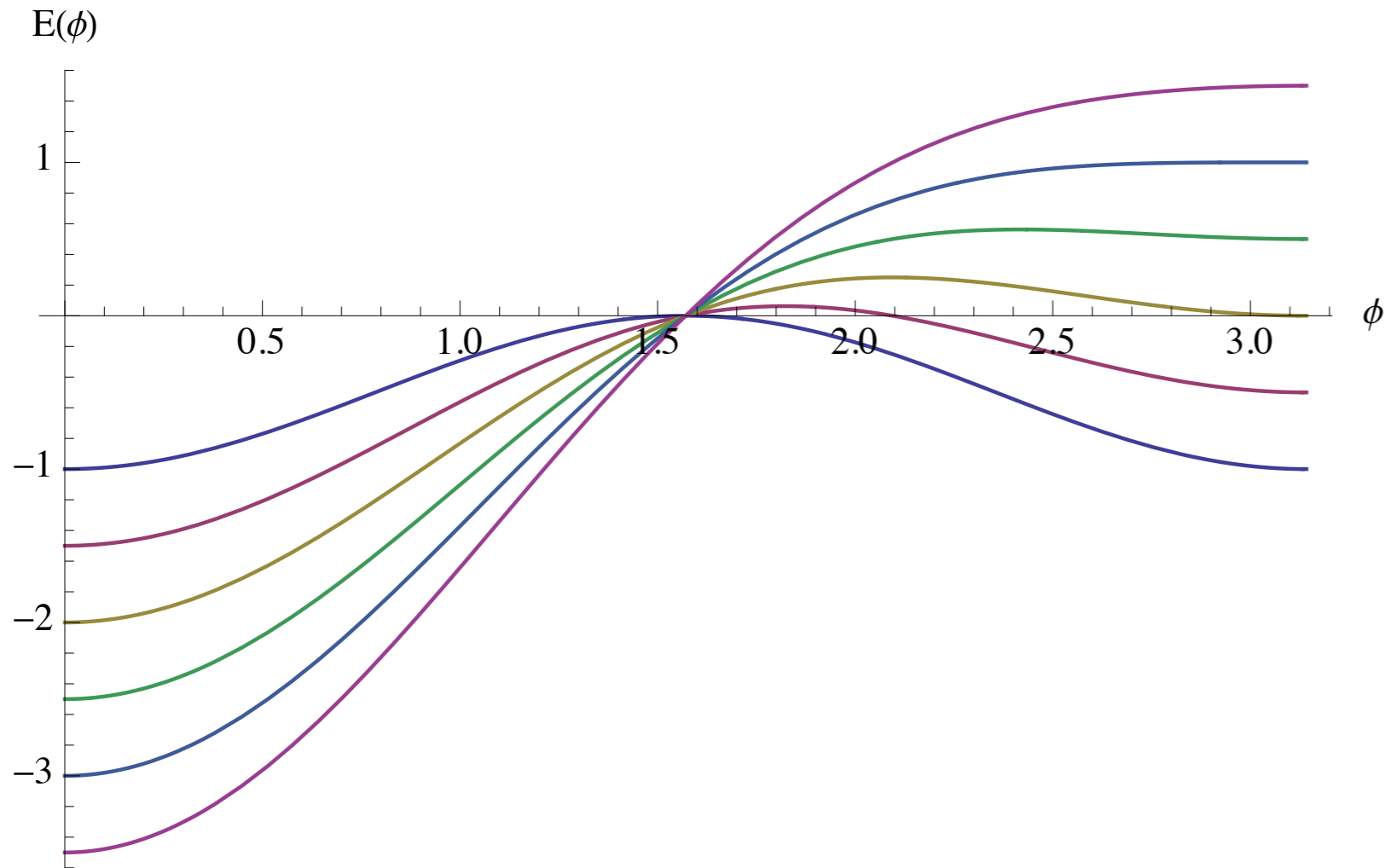
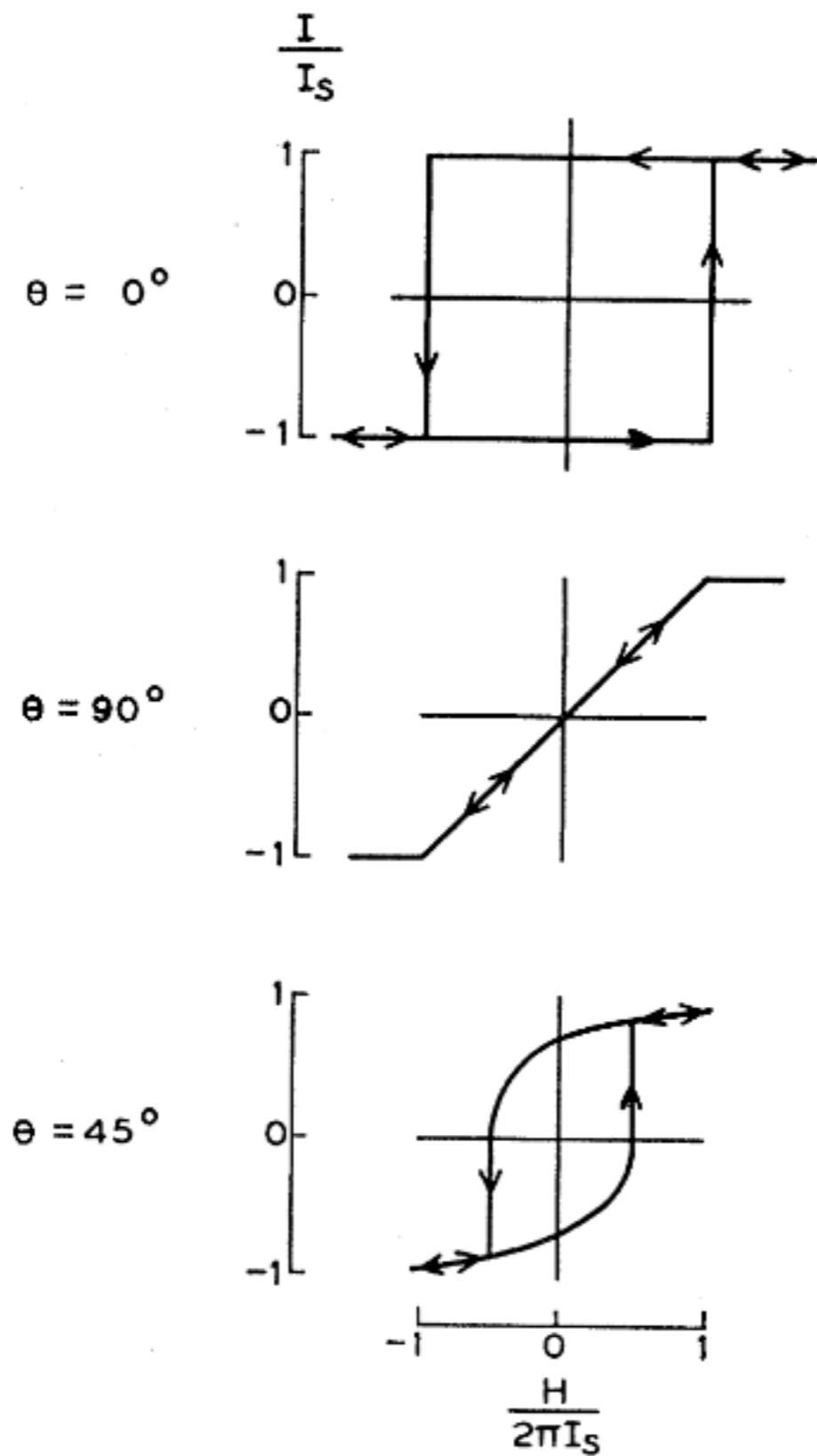

FIG. 1. Magnetization curve of single crystal of silicon iron. The B scale is only approximate. (Williams and Shockley, 1949.)

$$E = -K(\hat{\mathbf{M}} \cdot \mathbf{n})^2 - \mu_0 \mathbf{M} \cdot \mathbf{H},$$



Stoner Wohlfarth model



$$E = -K \cos^2 \phi - \mu_0 M H \cos \phi,$$

FIG. 47. Magnetization curves for elongated particles, for the applied field parallel, perpendicular, and at 45° to the long axis of the particle.

4. Kaj je gigantska magnetoupornost? Kako izdelamo naprave s to lastnostjo? Kje se uporabljajo?

Anisotropic magnetoresistance

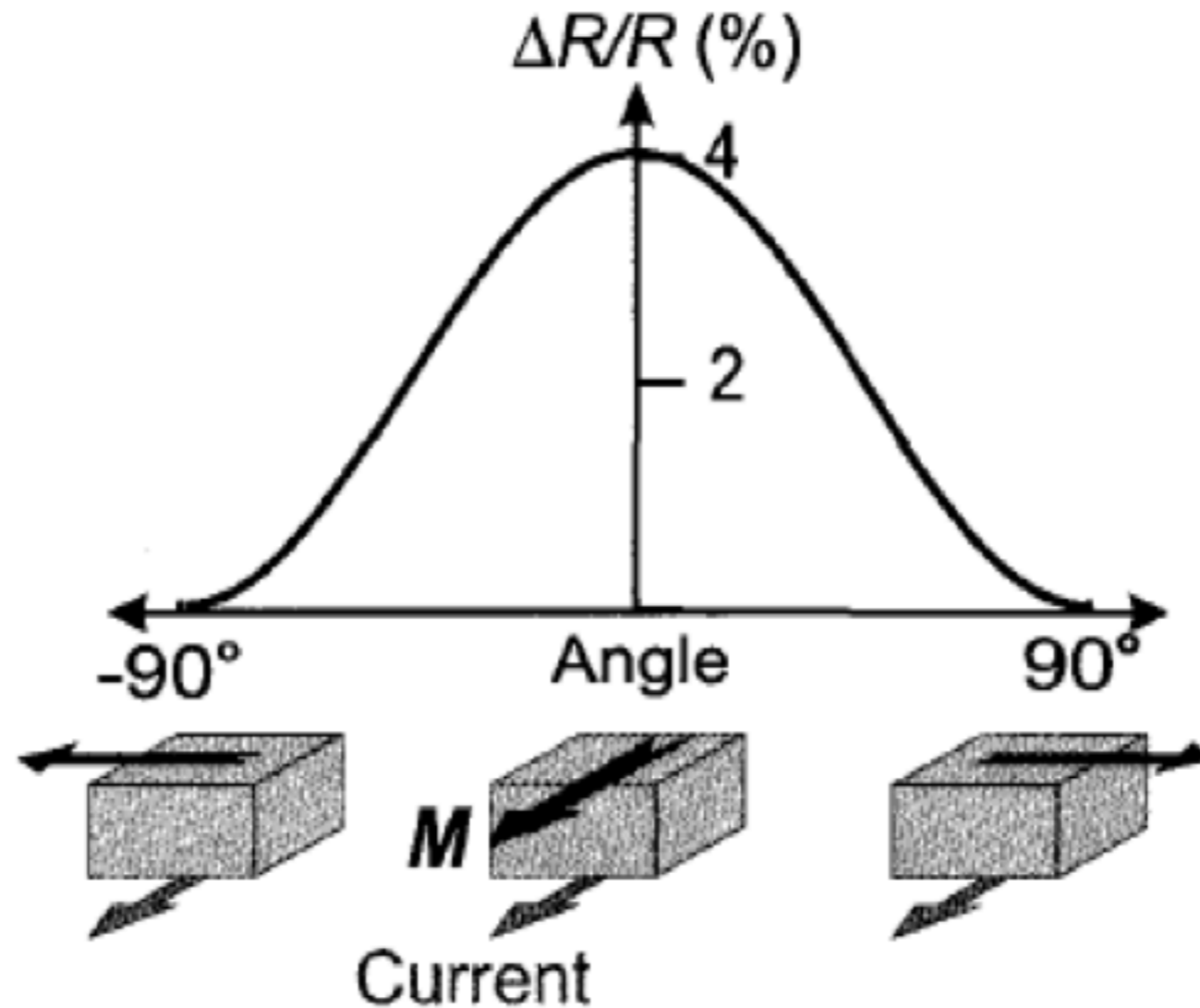

Nastane zaradi sklopitve spin-tir + Lorentzeve sile

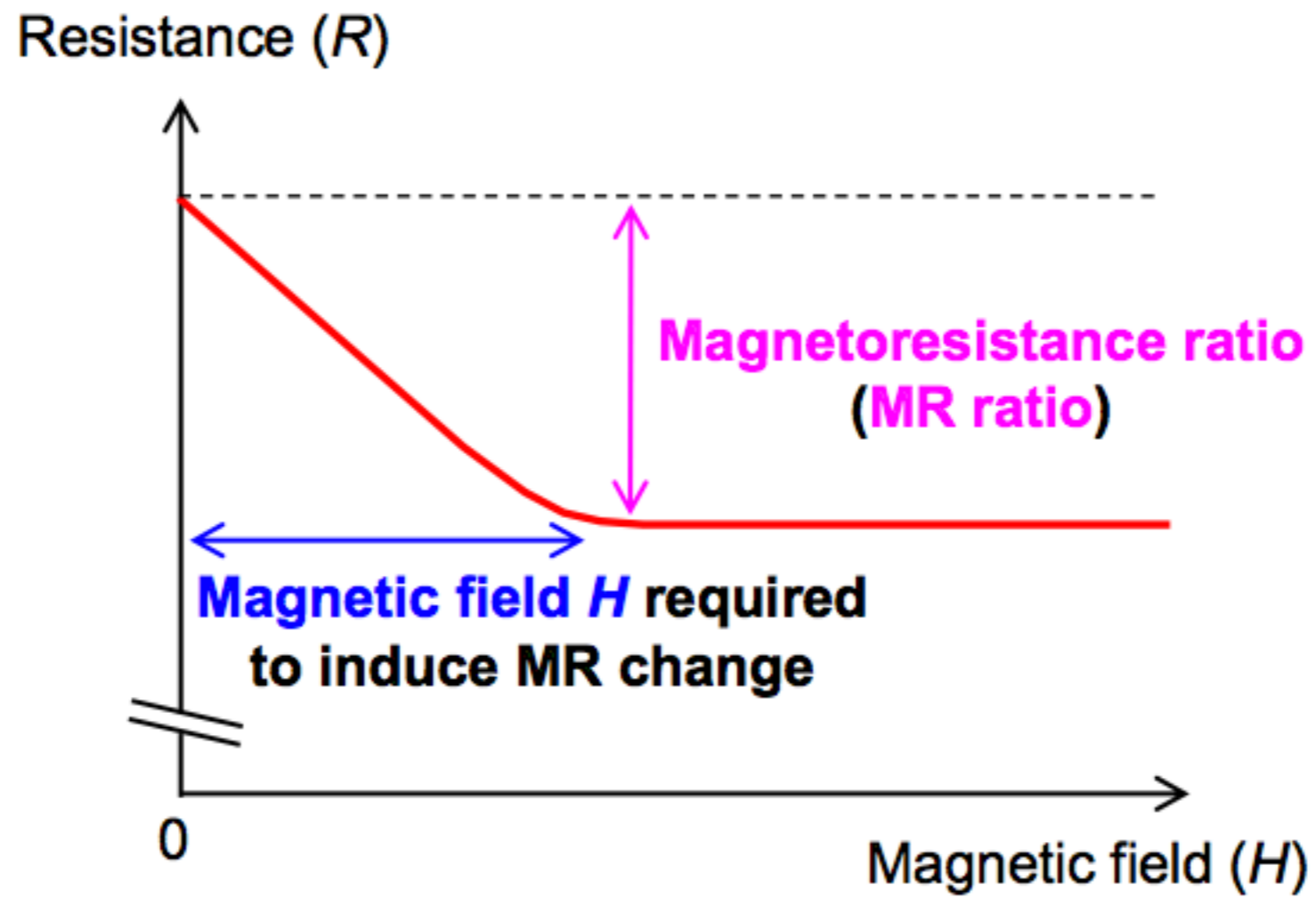

AMR sensorji

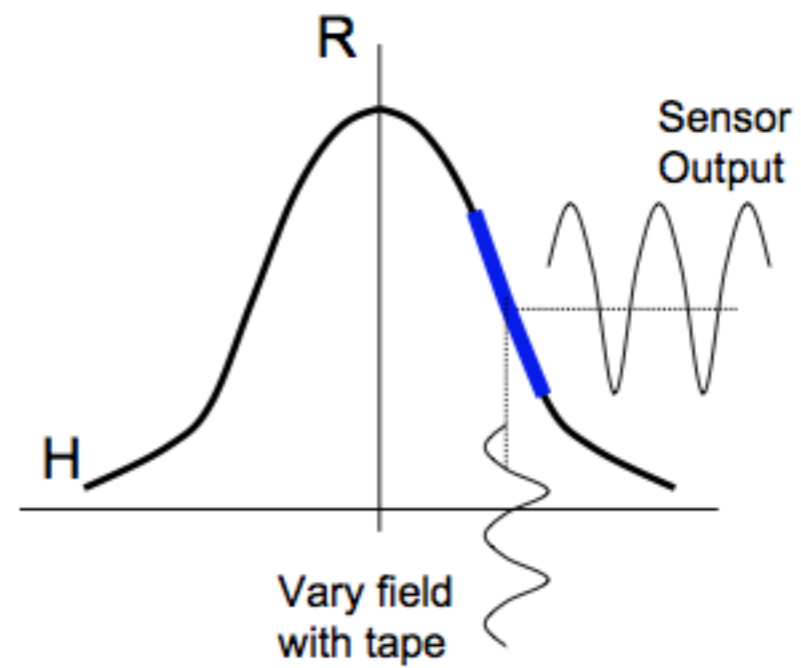
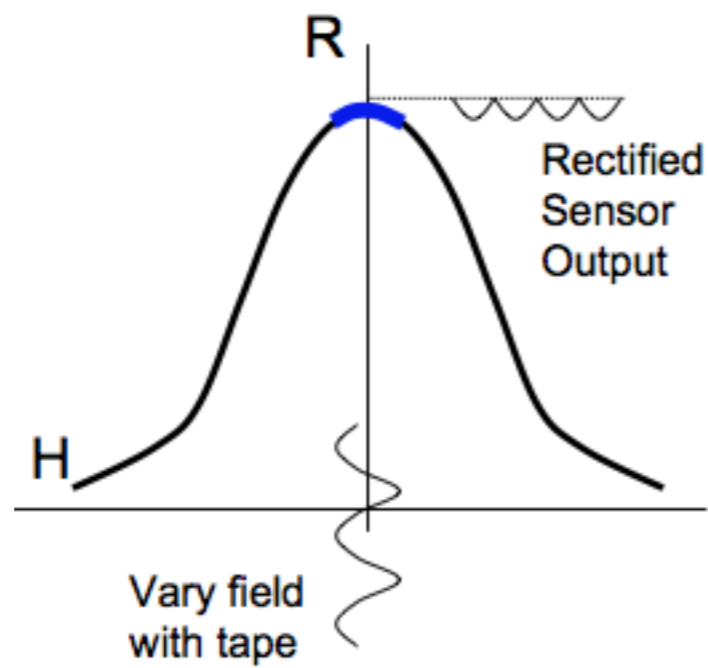

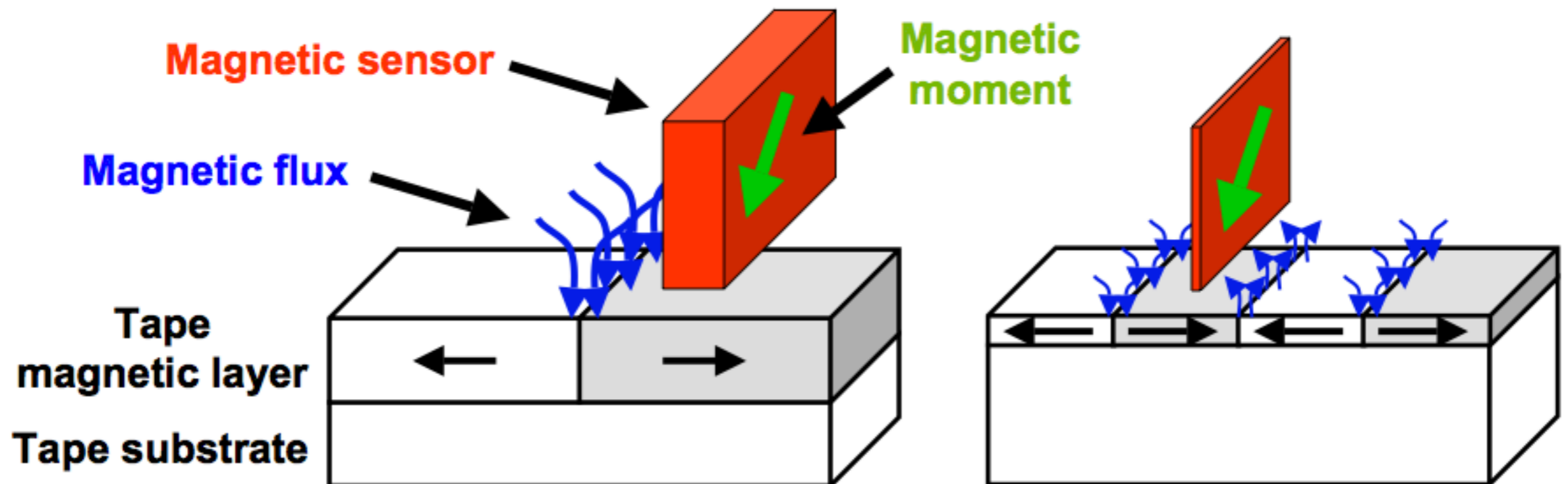
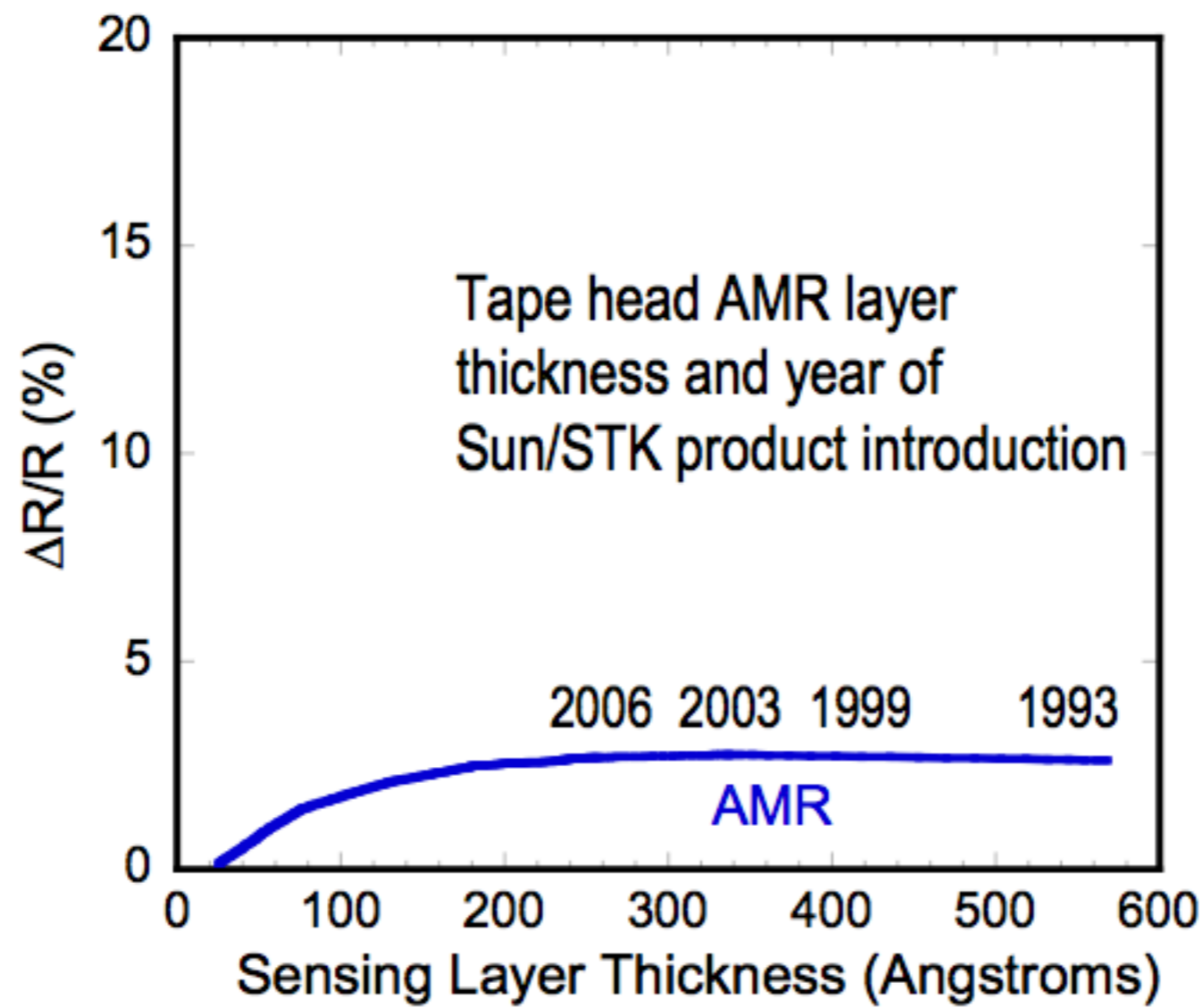

GIGANTSKA MAGNETOUPORNOST

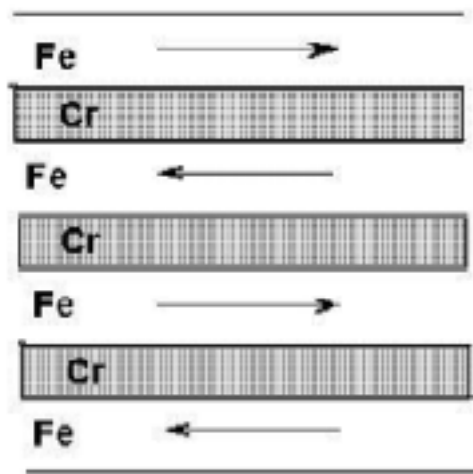

H=0

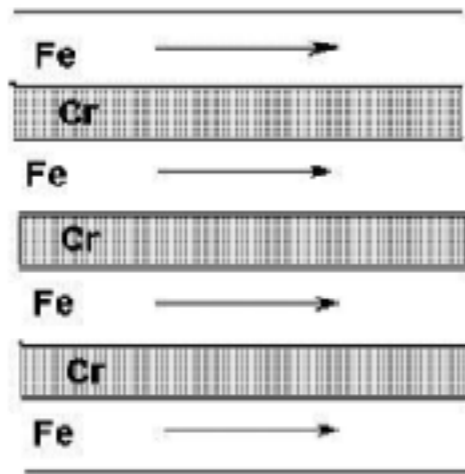

H=Hs

$$\updownarrow l = \lambda_F = 2\pi/k_F$$

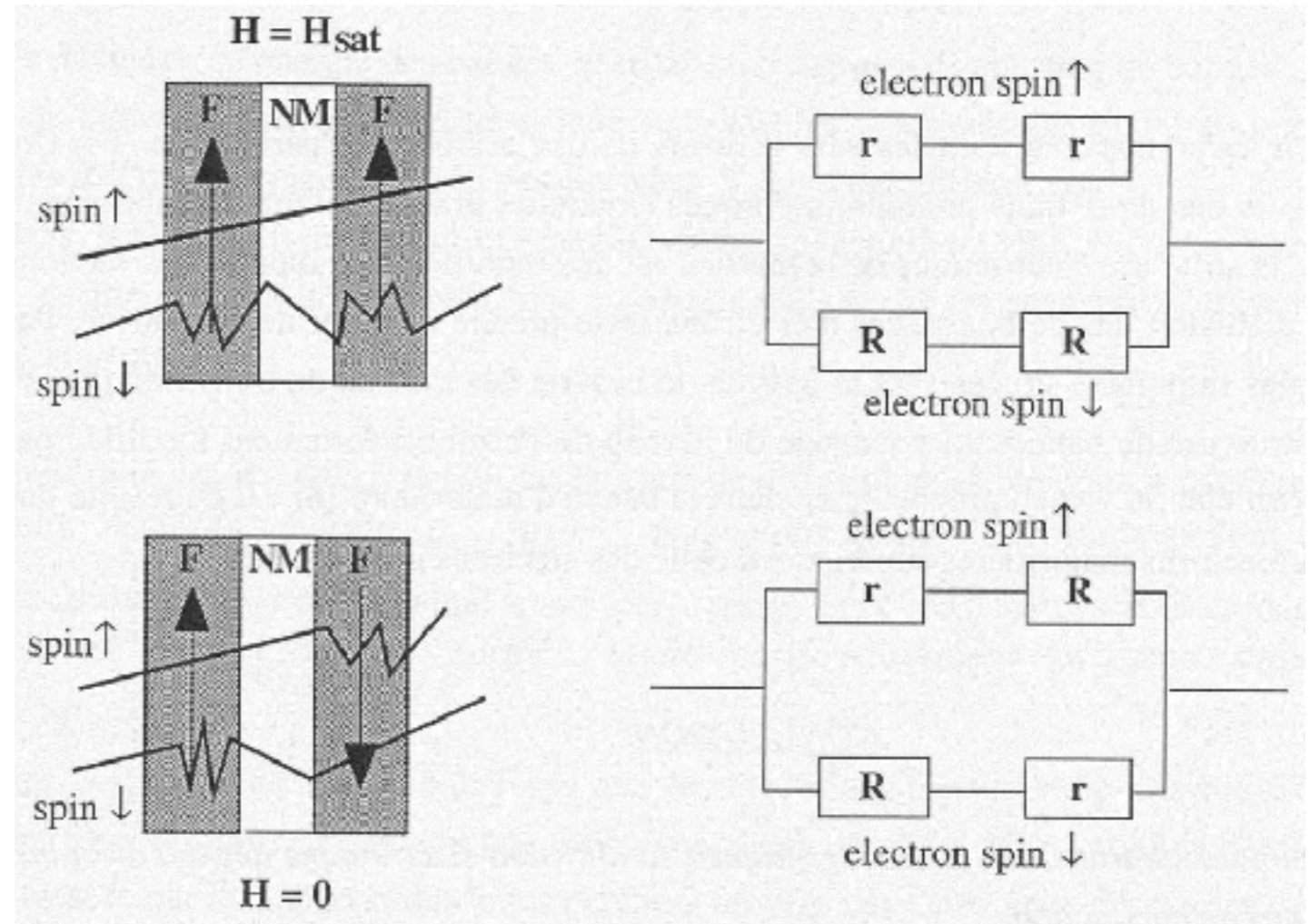

A. Fert, P. Grünberg, 1988 (Nobelova 2007)



Fe/Cr/Fe trilayer, P. Grünberg,
room temperature

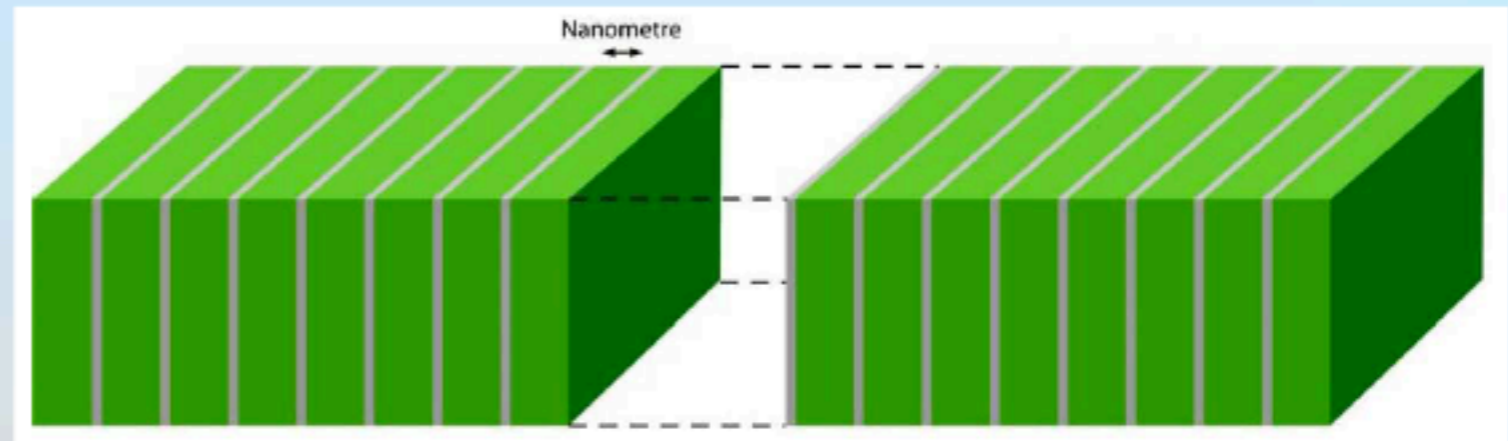

(FeCr) $_n$, $n=60$. A. Fert,
Liquid He temperature

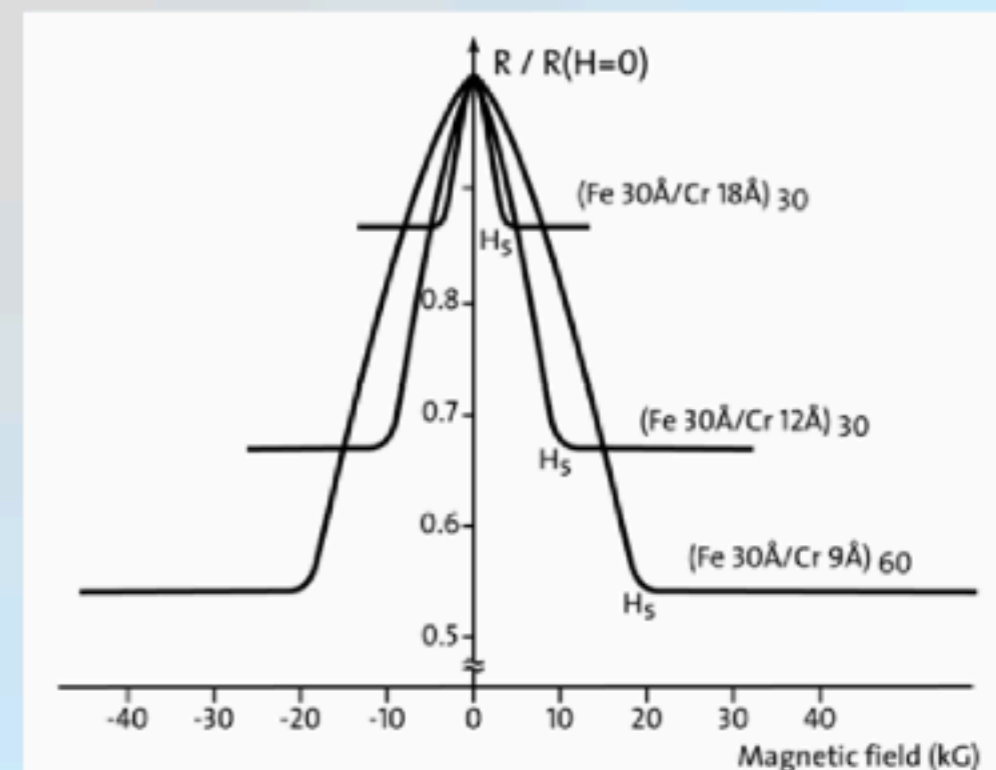
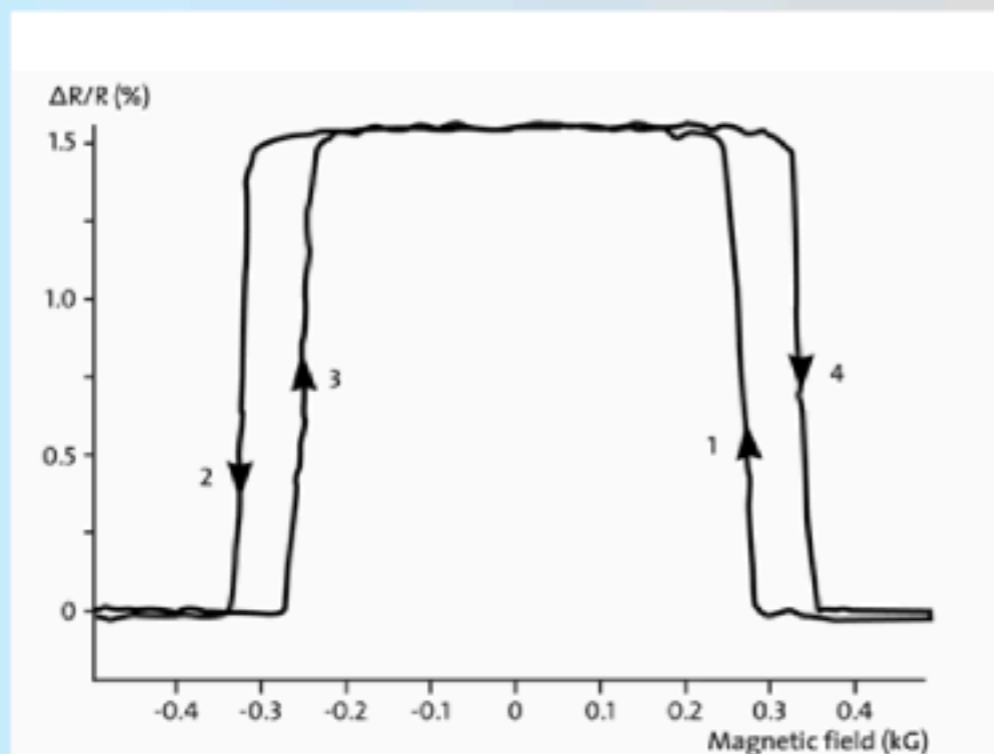

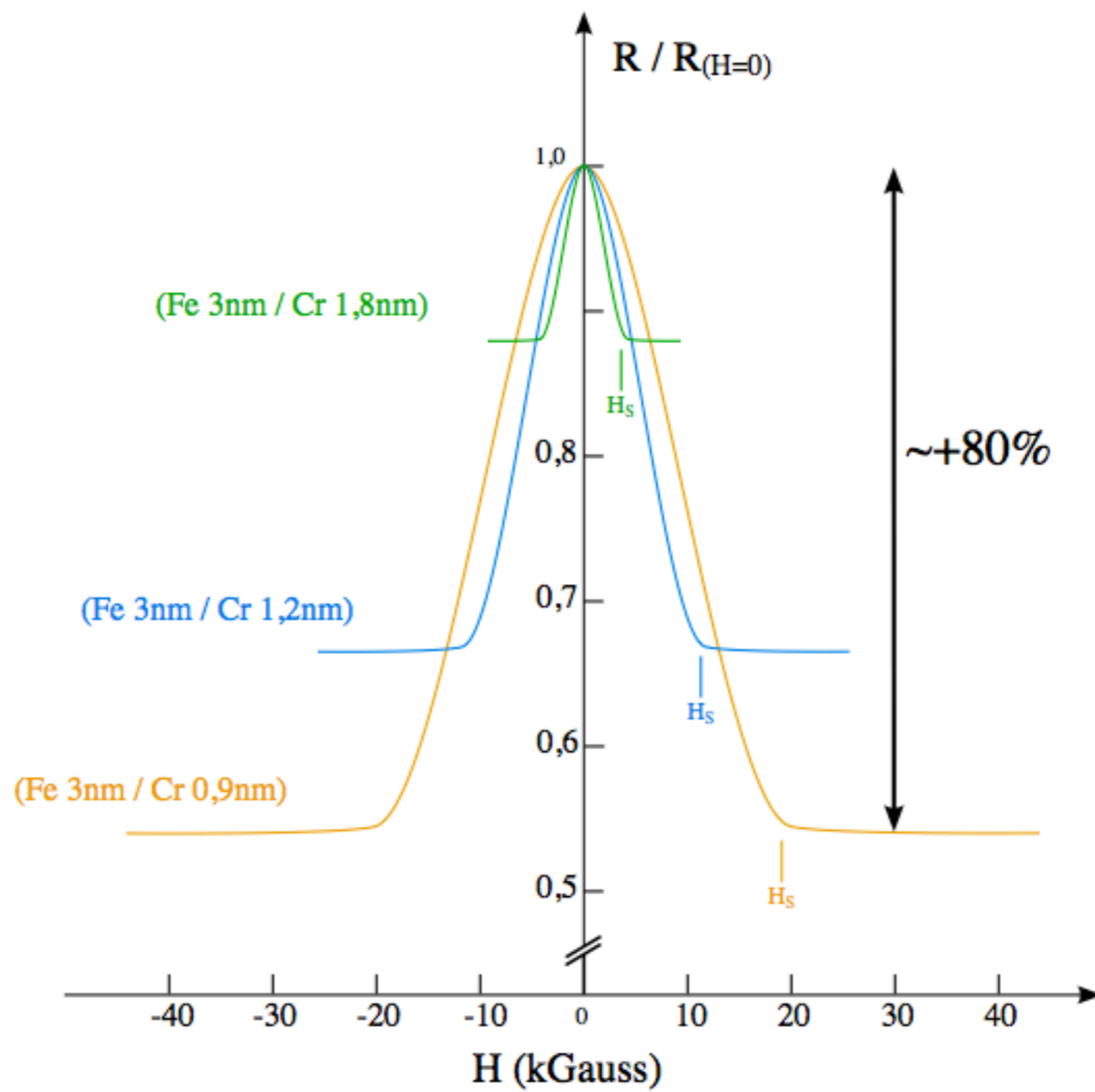



The Nobel Prize in Physics 2007

"for the discovery of Giant Magnetoresistance"

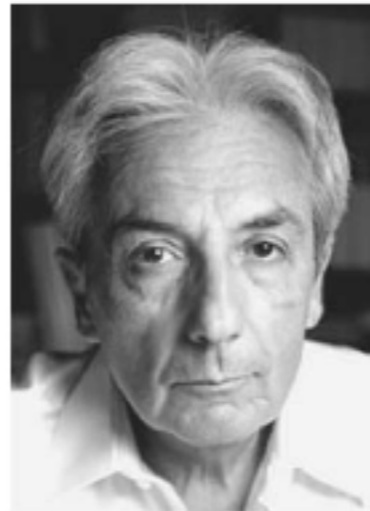

Photo: B. Fert,
Invisuphoto

Albert Fert

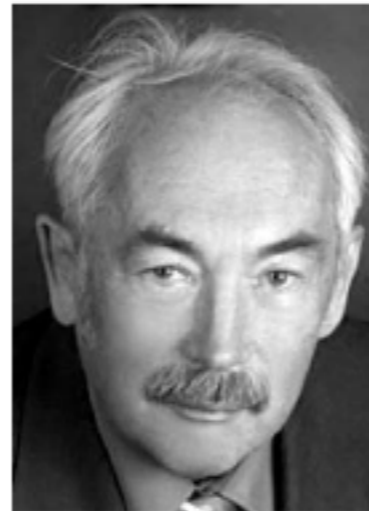
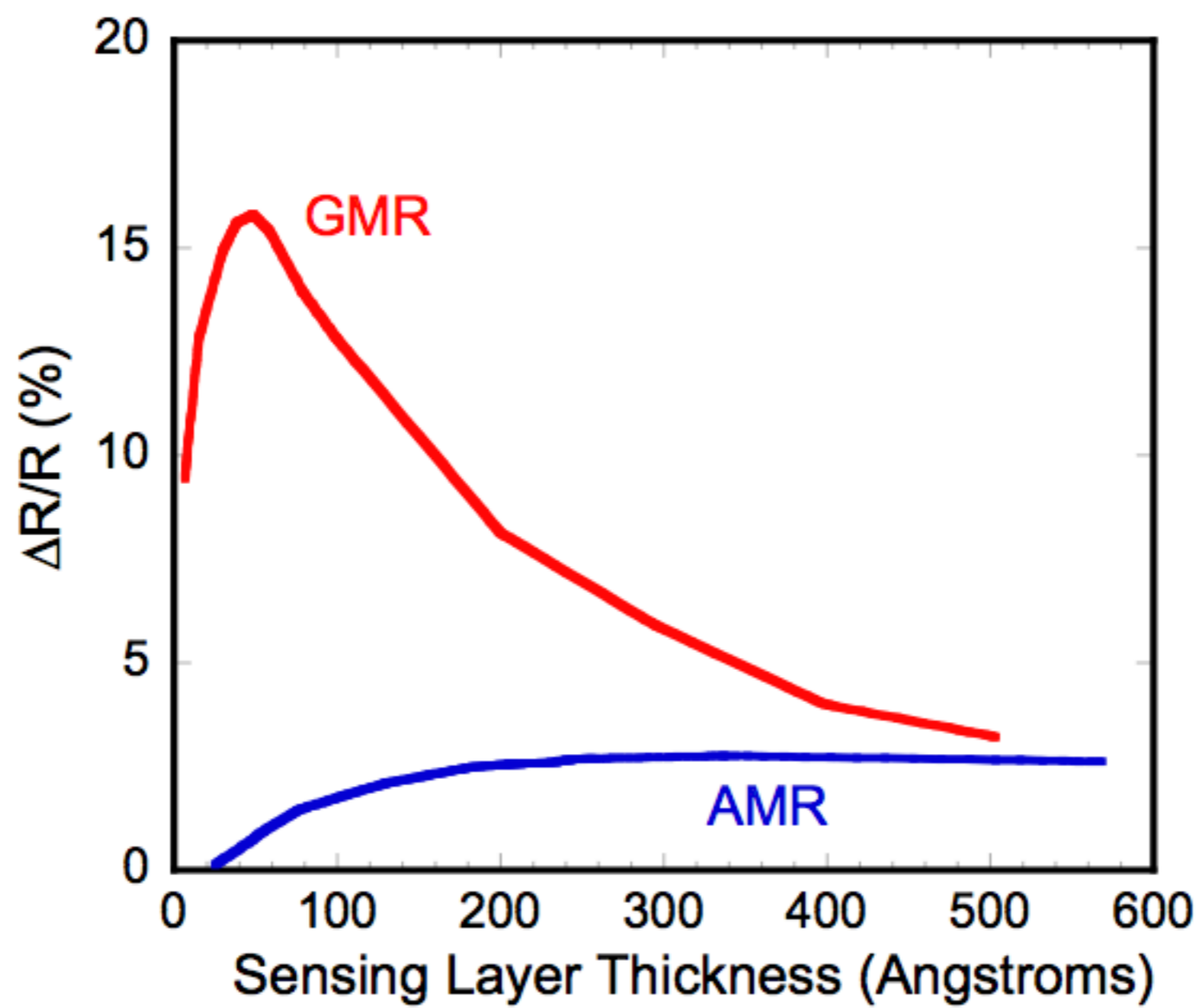

Photo: ©
Forschungszentrum
Jülich

Peter Grünberg

"This year's physics prize is awarded for the technology that is used to read data on hard disks. It is thanks to this technology that it has been possible to miniaturize hard disks so radically in recent years"



GMR Head Structure

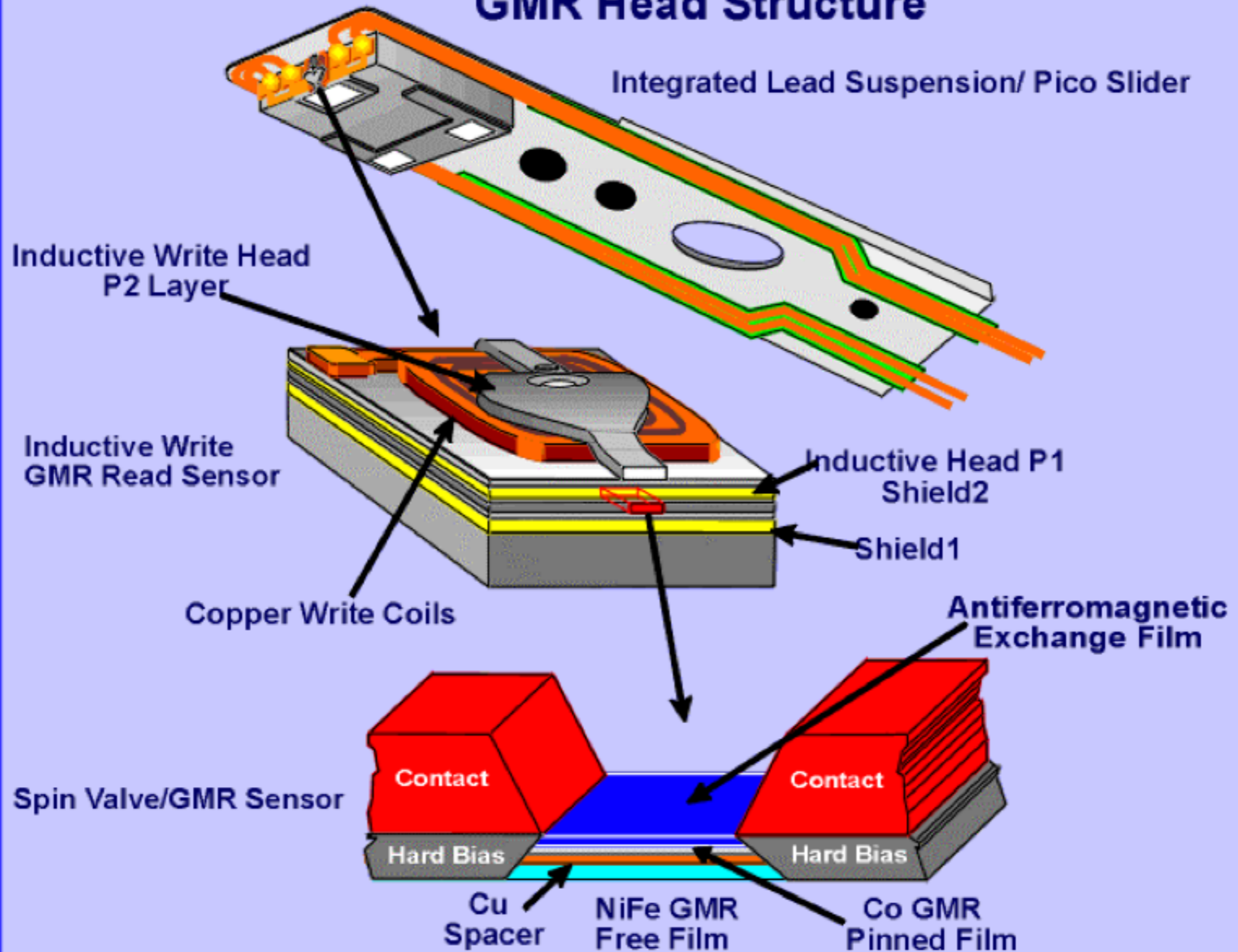

TUNELSKA MAGNETOUPORNOST (SPINSKI VENTIL)

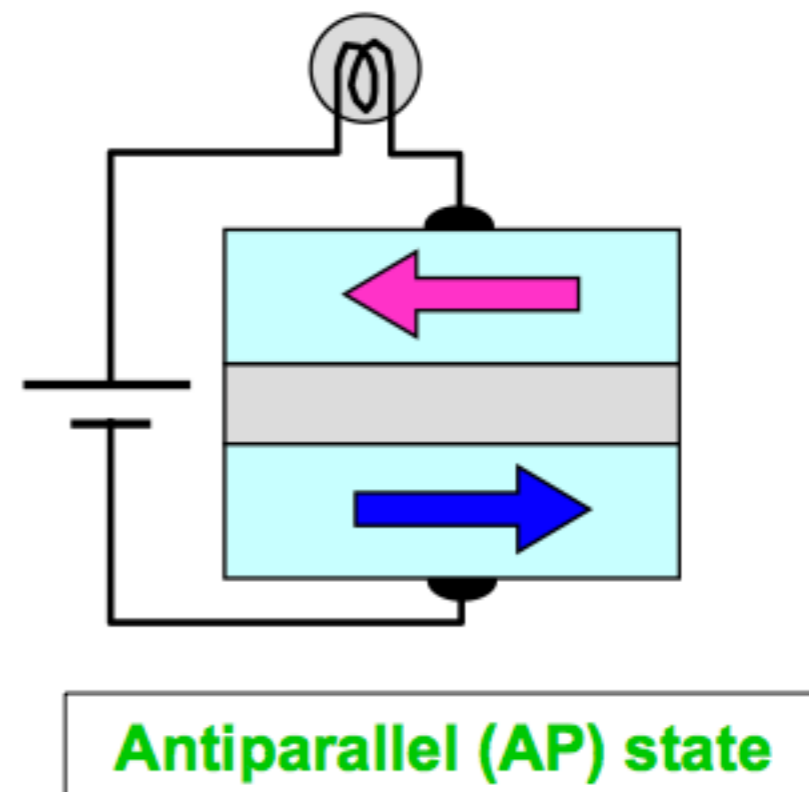
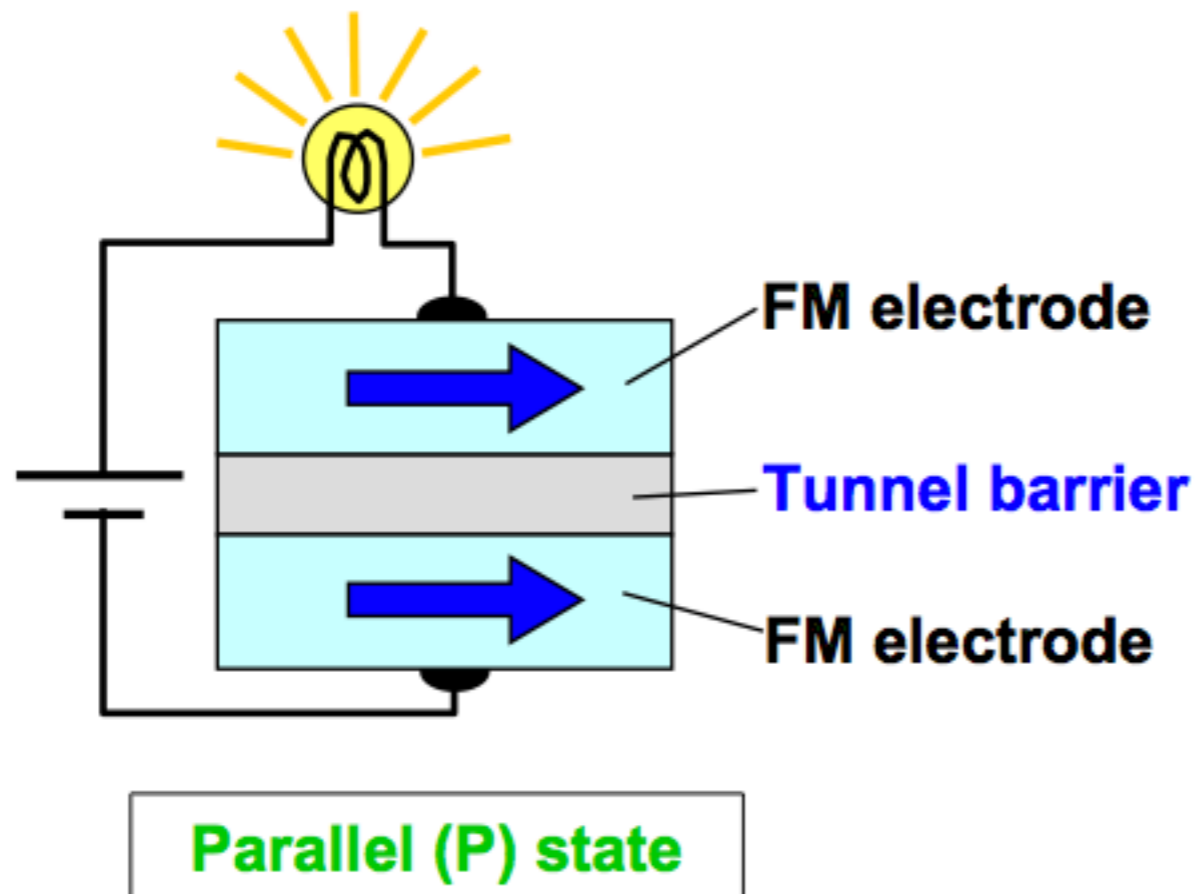

$$\cos^2(\theta/2)$$

magnetni
tunelski spoj

Miyazaki, Moodera (1995)
(prvič pri sobni temperaturi)

AMR: MR=2% v $\text{Ni}_{80}\text{Fe}_{20}$ (permalloy)

GMR: MR=20% v Co/Cu/Co

TMR: MR=250% v Co/MgO/Co

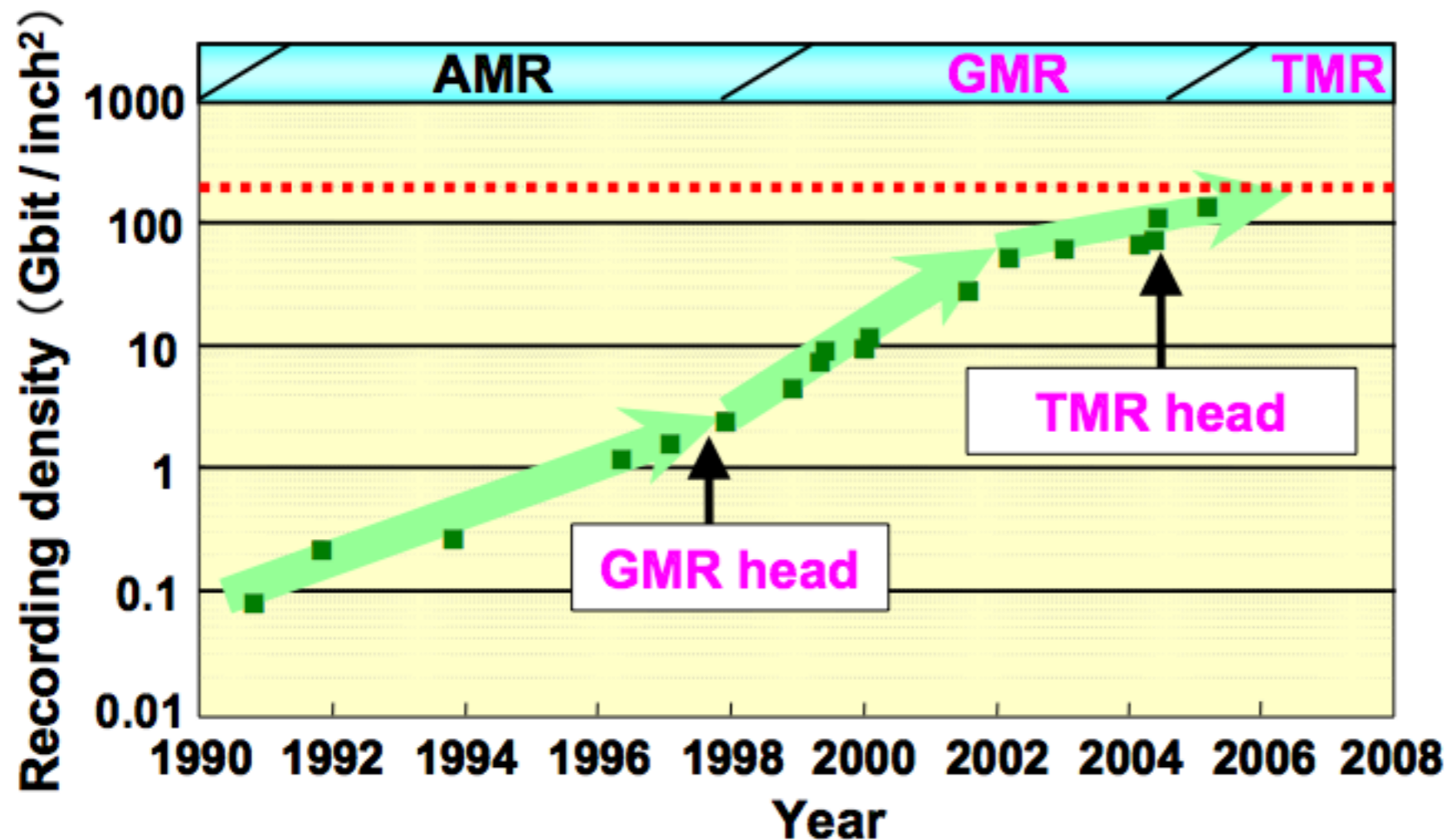

Kryderjev zakon: faktor 1000 v desetih letih.

HRANJENJE PODATKOV

I. Kaj je superparamagnetizem in Neelov relaksacijski čas?

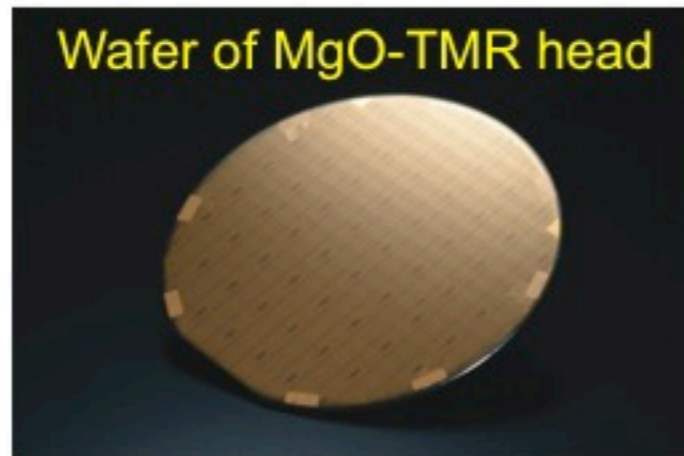

Wafer of MgO-TMR head

Cut
Integration



MgO-TMR head



Integration



Magnetic shield (top lead)

Permanent magnet

Permanent magnet

MgO-MTJ

Magnetic shield (bottom lead)

20 nm

TEM image

- ◆ Commercialized since 2007.
- ◆ 500 Gbit / inch² achieved (density *tripled*).
- ◆ Applicable up to 1 Tbit / inch² (at least).

2. Kako deluje tranzistor s plavajočimi vrati? Zakaj je število pisalnih ciklov omejeno?

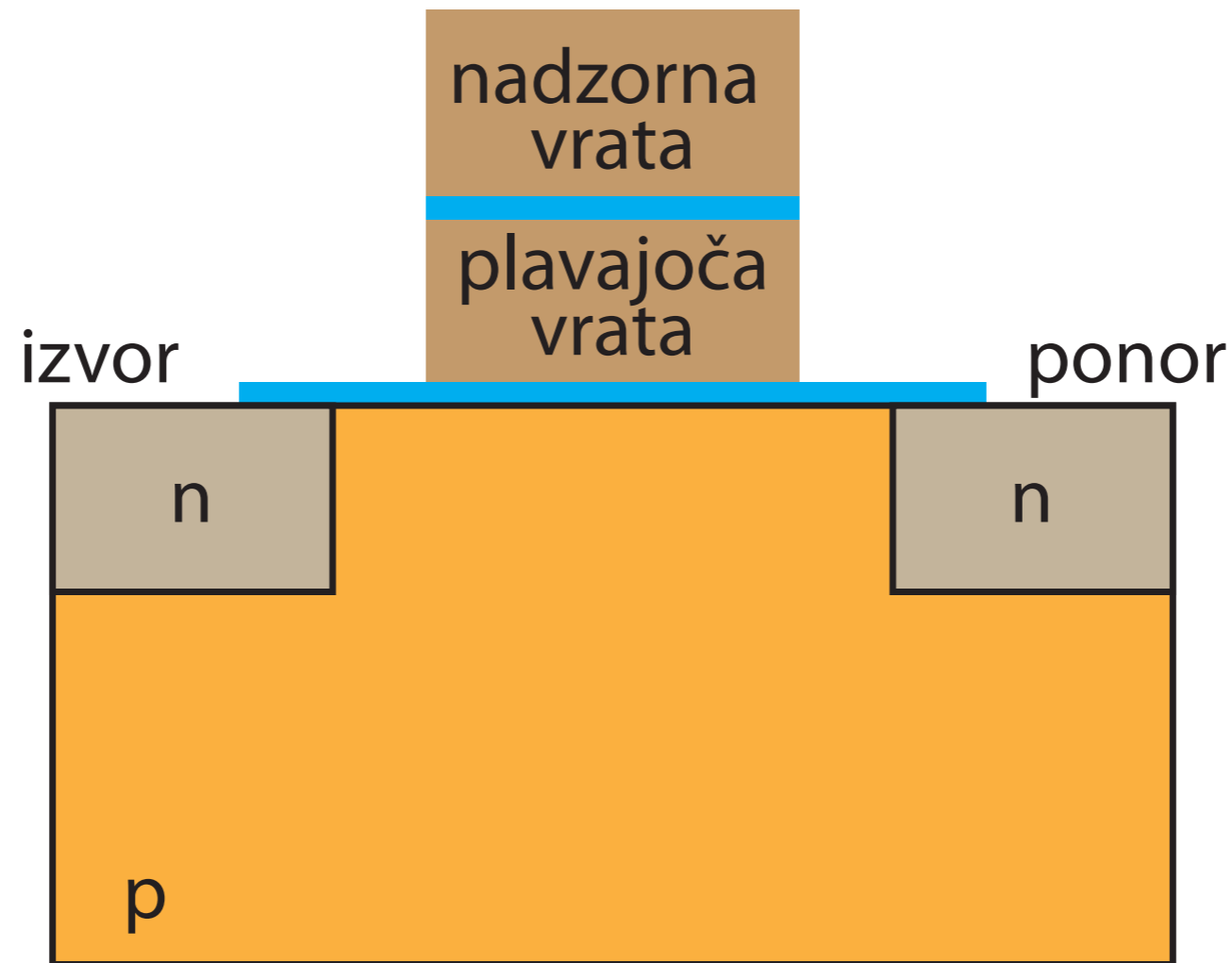

Asimetrija: pisanje veliko počasnejše.

- MLC
 - 3-4 bits per cell @ 10K duty cycles
- SLC
 - 1 bit per cell @ 100K duty cycles
- eMLC
 - 2 bits per cell @ 30K duty cycles

4. Kako deluje MRAM? Kaj so pogloblitve prednosti?

MRAM

M=magnetoresistive

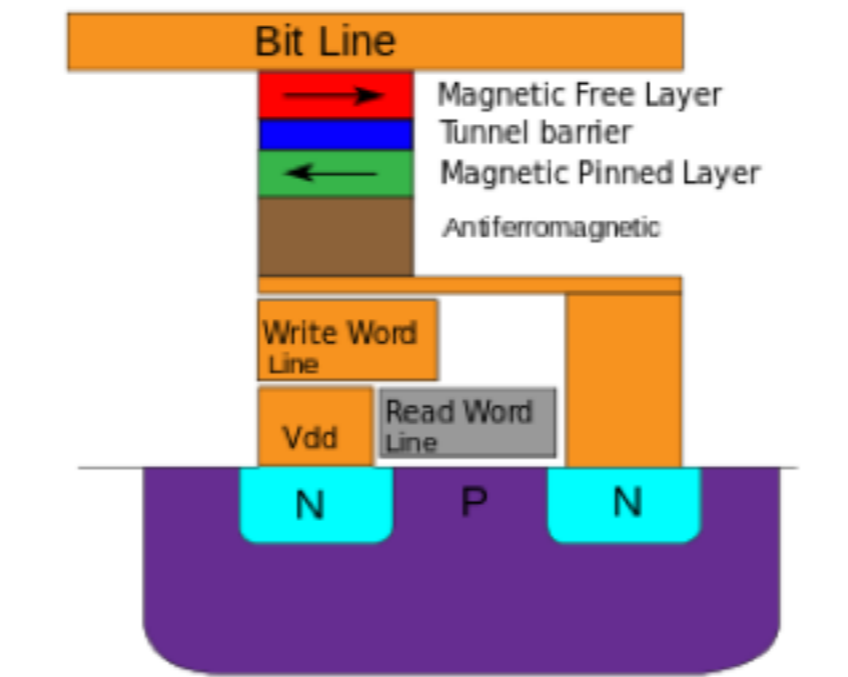

STT-RAM je izpopolnjena verzija MRAM

MRAM

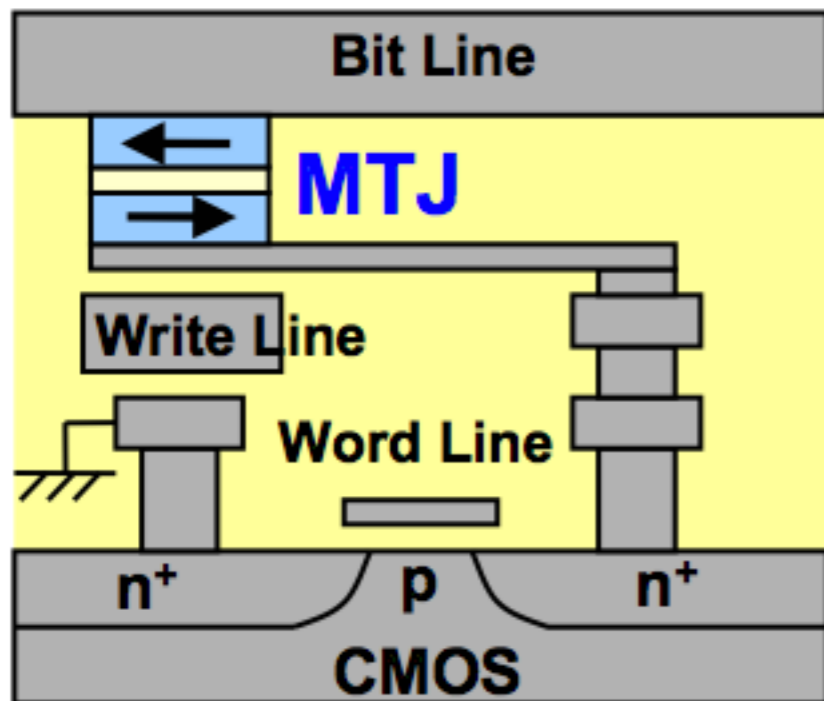
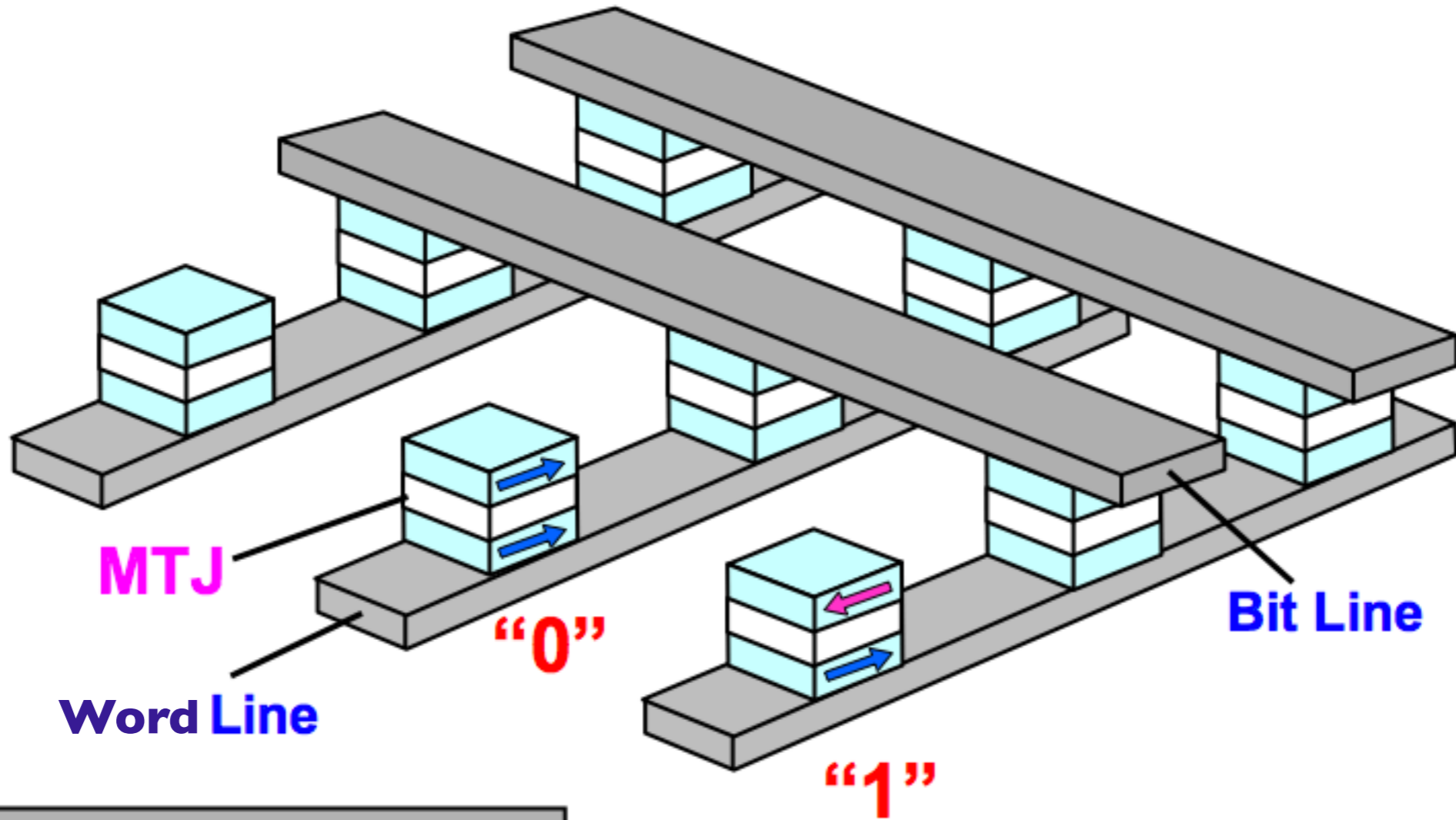

MR20H40 - 50MHz/20ns ¹SCK (Industrial Temp Range) 4Mb SPI Interface MRAM

MR25H40 - 40MHz/25ns ¹SCK (Industrial, Extended and AEC-Q100 Grade 1 Temp Range) 4Mb SPI Interface MRAM

For more information on product options, see "Table 16 – Ordering Part Numbers" on page 24.

FEATURES

- No write delays
 - Unlimited write endurance
 - Data retention greater than 20 years
 - Automatic data protection on power loss
- Fast, simple SPI interface, up to 50 MHz clock rate with MR20H40.
 - 3.0 to 3.6 Volt power supply range
 - Low-current sleep mode
 - Industrial (-40 to 85°C), Extended (-40 to 105°C), and AEC-Q100 Grade 1 (-40 to 125°C) temperature range options.
 - Available in 8-pin DFN or 8-pin DFN Small Flag, RoHS-compliant packages.
 - Direct replacement for serial EEPROM, Flash, and FeRAM
 - MSL Level 3



8-DFN



8-DFN Small Flag



Memory Taxonomy

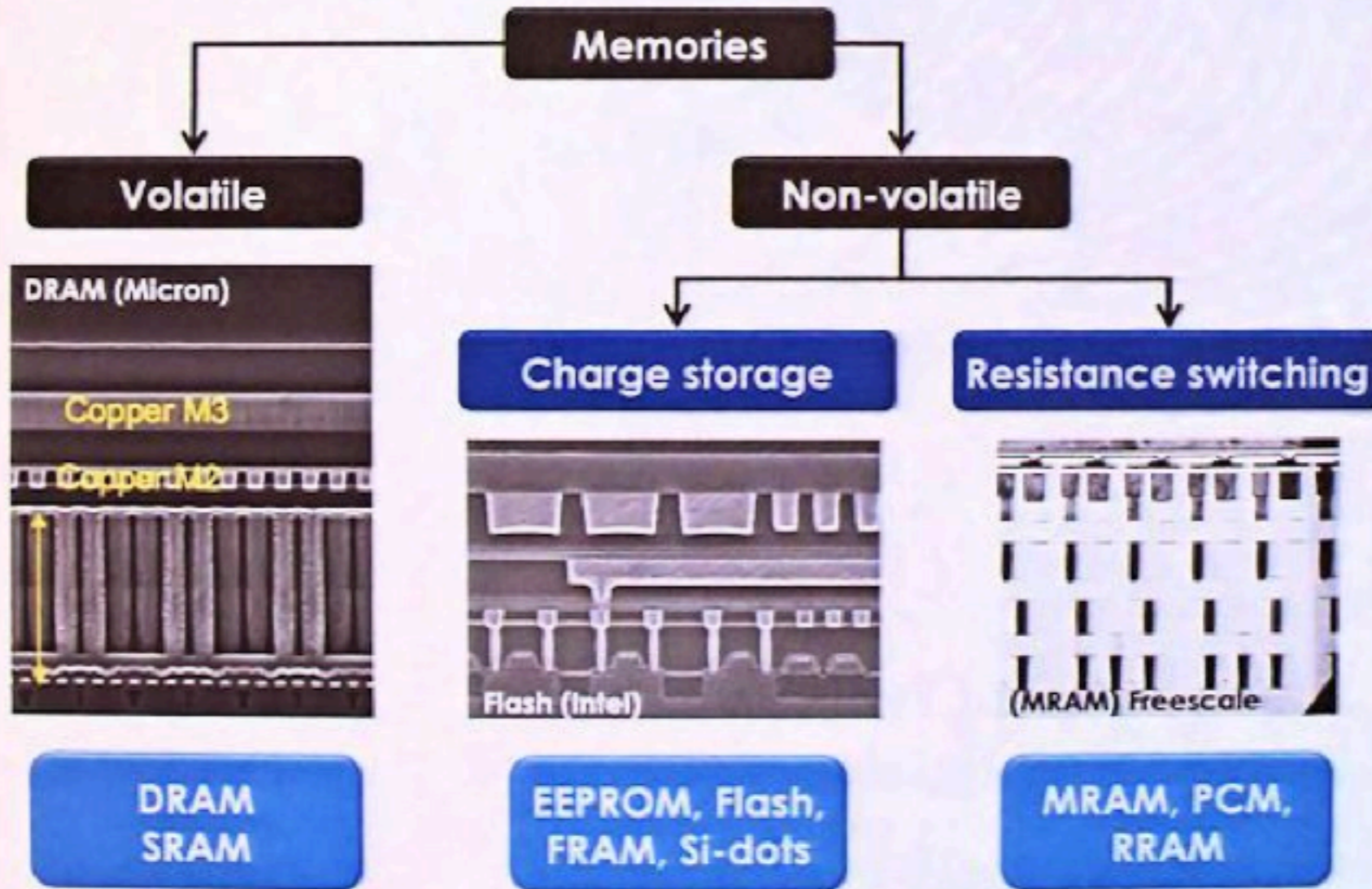

Phase Change Memory (PCM)

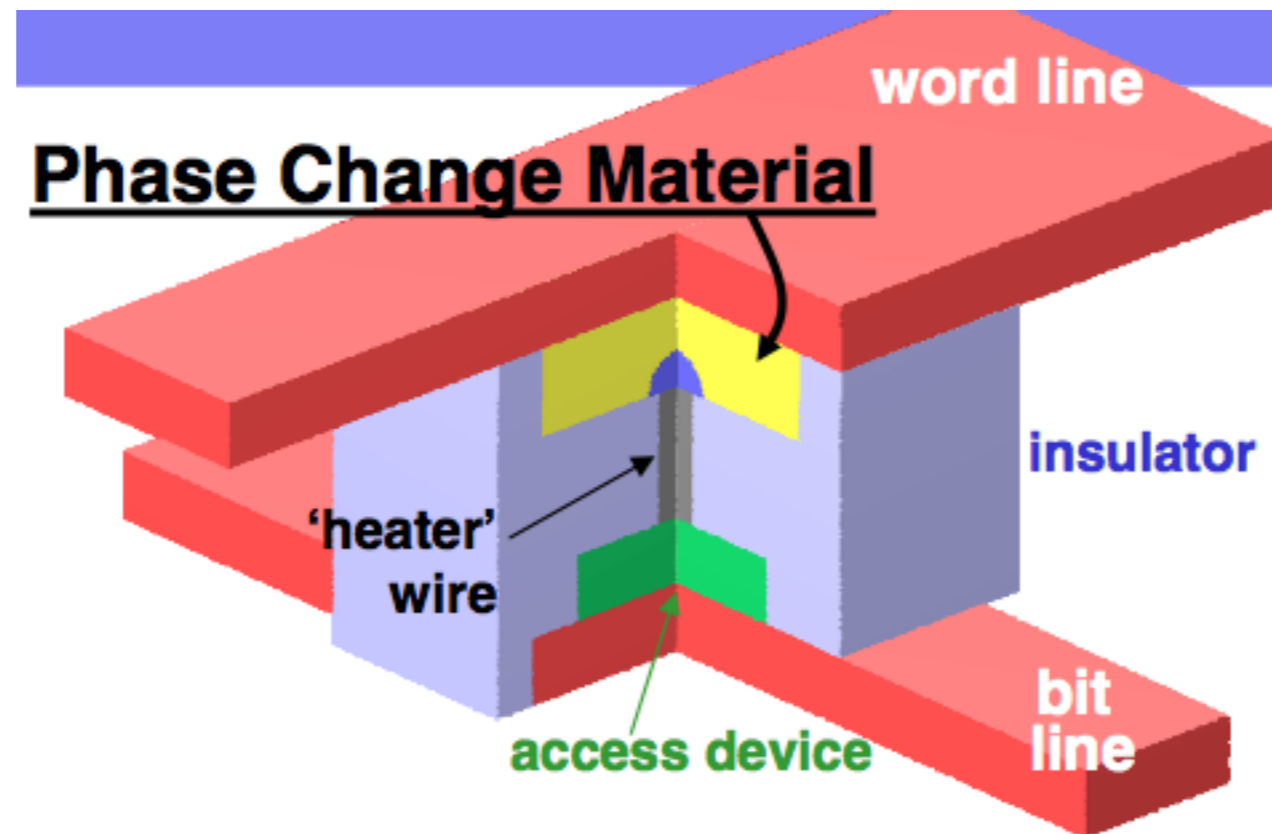

GeSbTe (GST)

P5Q Serial Phase Change Memory (PCM)

**NP5Q032AE3ESFC0E, NP5Q064AE3ESFC0E
NP5Q128A13ESFC0E, NP5Q128AE3ESFC0E**

Features

- Density range: 32Mb, 64Mb, 128Mb
- SPI bus compatible serial interface
- Maximum clock frequency
 - 66 MHz (0°C to +70°C)
 - 33 MHz (-40°C to +85°C)
- 2.7V to 3.6V single supply voltage
- Supports legacy SPI protocol and new quad I/O or dual I/O SPI protocol
- Quad I/O frequency of 50 MHz, resulting in an equivalent clock frequency up to 200 MHz
- Dual I/O frequency of 66 MHz, resulting in an equivalent clock frequency up to 132 MHz
- Continuous READ of entire memory via single instruction:
 - Quad and dual output fast read
 - Quad and dual input fast program
- Uniform 128KB sectors (Flash emulation)
- WRITE operations
 - 128KB sectors ERASE (emulated)
 - Legacy Flash PAGE PROGRAM
 - Bit-alterable page WRITES
 - PAGE PROGRAM on all 1s (PRESET WRITES)
- Write protections: protected area size defined by four nonvolatile bits (BP0, BP1, BP2, and BP3)
- JEDEC-standard two-byte signature
 - 32Mb (DA16h)
 - 64Mb (DA17h)
 - 128Mb (DA18h)
- 32M, 64Mb, and 128Mb densities with SOIC16 package
- More than 1,000,000 WRITE cycles
- Phase change memory (PCM)
 - Chalcogenide phase change storage element
 - Bit-alterable WRITE operation

Resistive RAM (RRAM ali ReRAM)

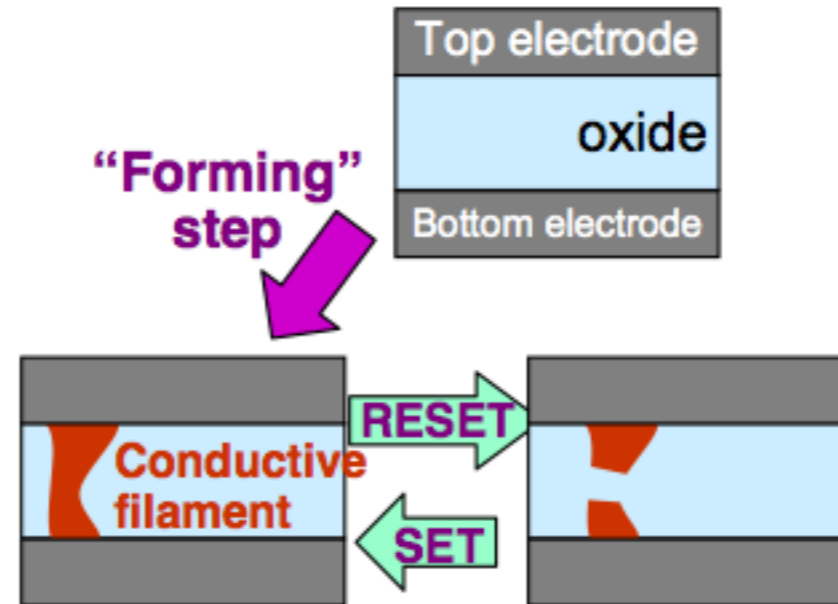

Podobno conductive-bridging RAM (CB RAM)
= programmable metallization cell (PMC)

Kovinski atomi iz elektrode preidejo v tanko plast

MEMRISTOR = MEMORY RESISTOR

$$U = R(q)I$$

$$\frac{dq}{dt} = I$$

memristancia: $M(q) = \frac{d\Phi}{dq}$

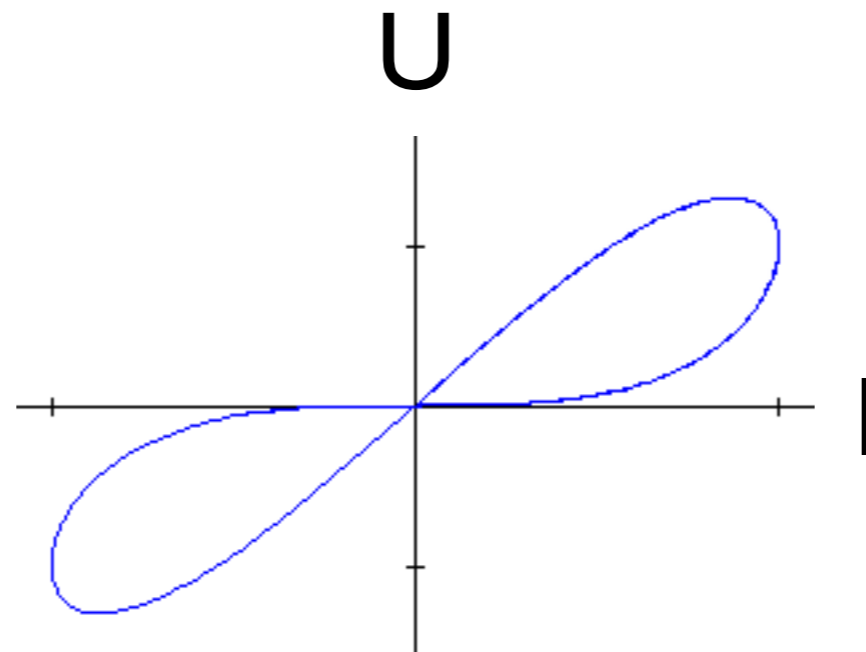

Intel Optane (3D XPoint)

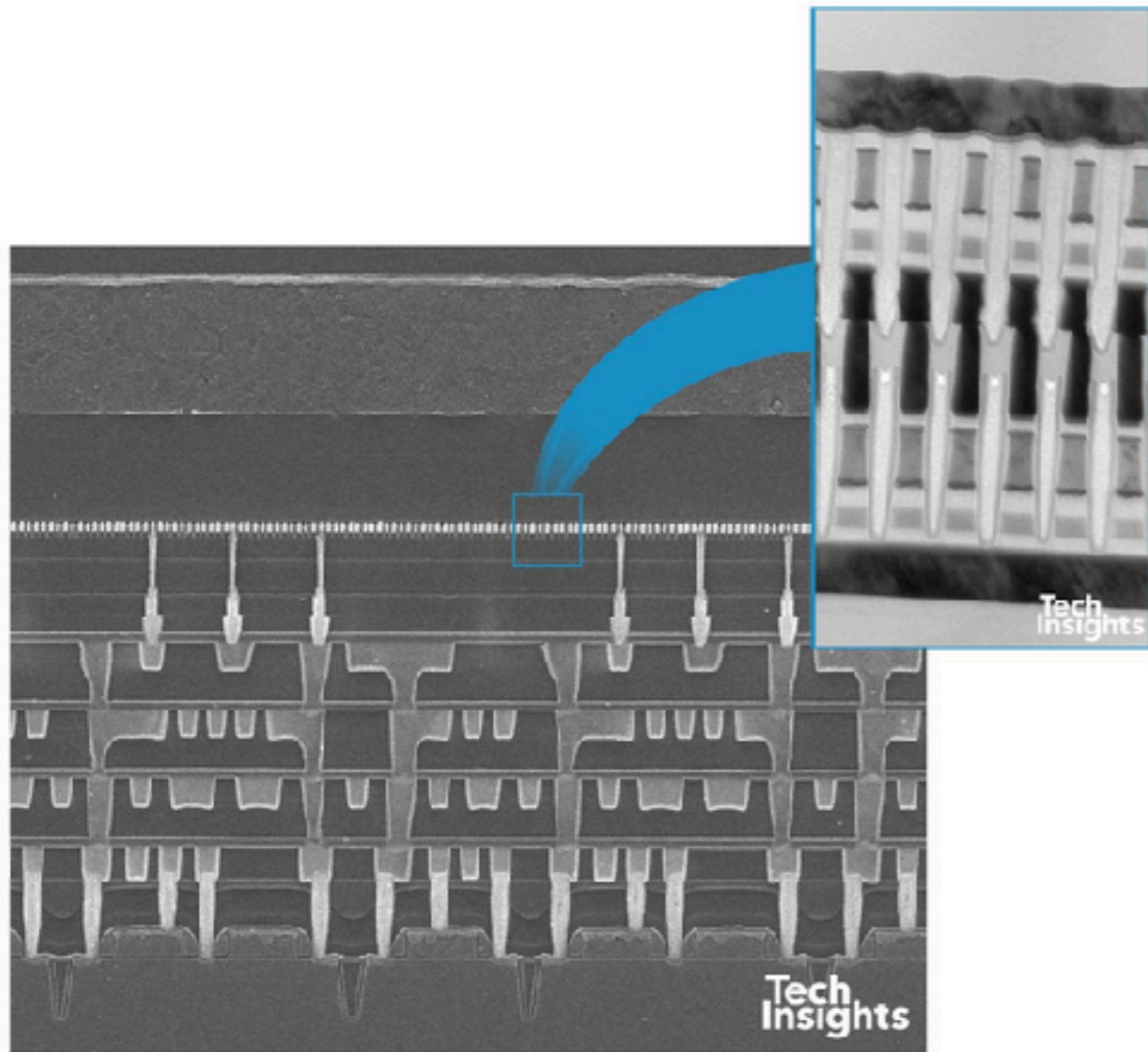

Intel Xpoint Memory is a PCM (Phase Change Memory) with a double storage-selector stacked memory cell between metal 4 and metal 5. GST-based materials are used for the storage, while As (arsenic) doped chalcogenide materials (Se-Ge-Si) are used for the selector in which As might be used to suppress crystallization. This is likely a type of Ovonic Threshold Switch (OTS) structure. We found that the 3D Xpoint memory layers are placed between metal 4 and metal 5 and connected with a few selector contact plugs on metal 4. We'll be digging deeper into the device to find more innovative technology, and we'll share that with you in the near future.

ovonic threshold switch (OTS)

Figure 3: X-point Memory Array X-section SEM and TEM images

Magnetic racetrack memory

Domain wall devices

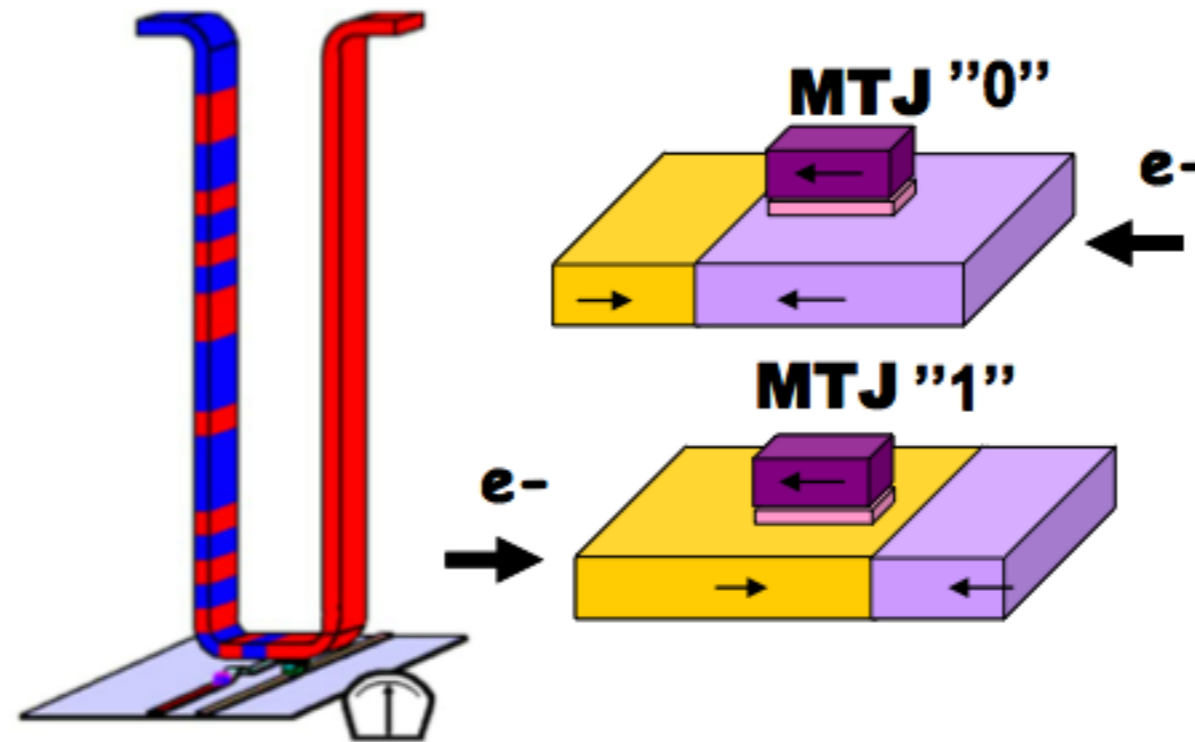

Parkin et al., Science

320, 190 (2008).

Pomnilnik iz atomskih verig

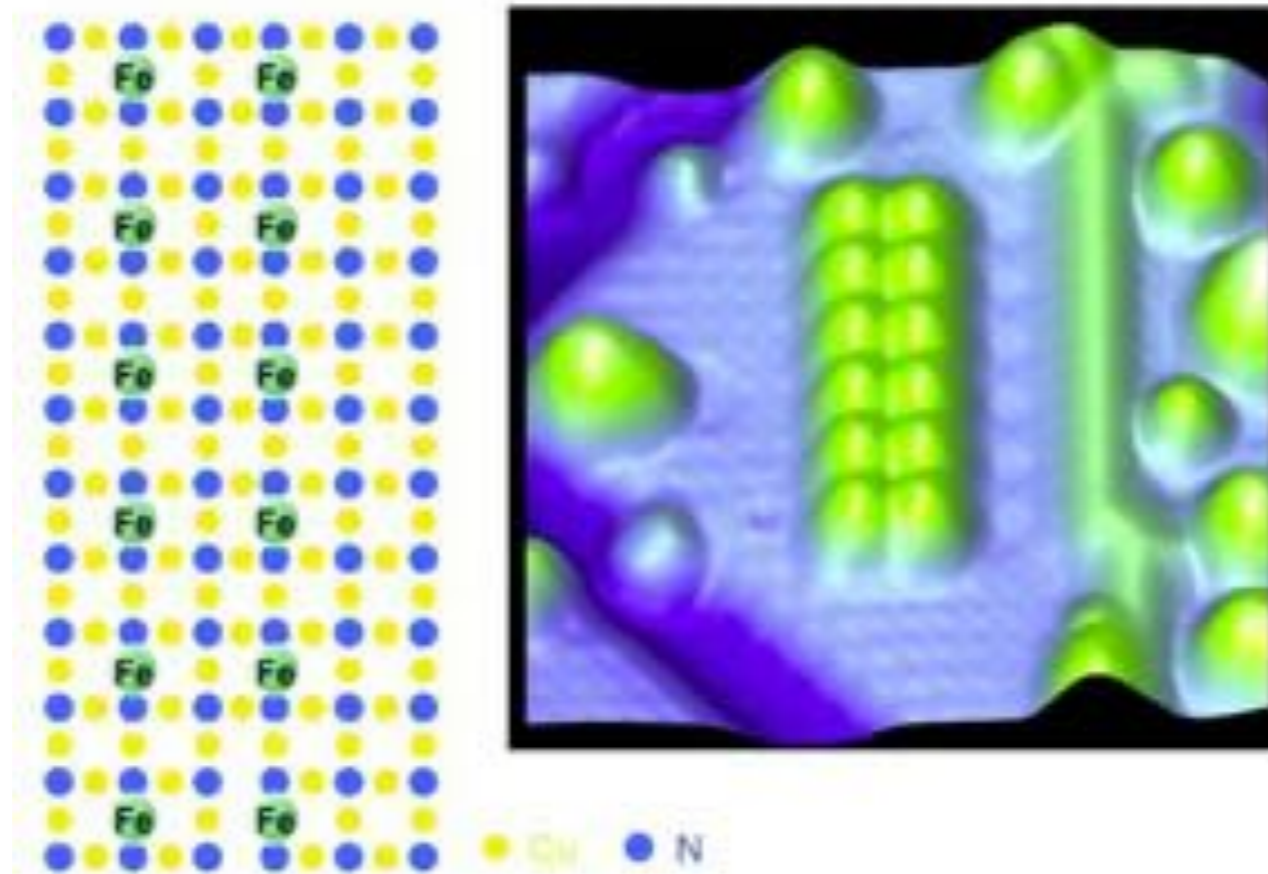

relaksacijski čas: >17 ur
vendar pri $T=100\text{mK}$

4. Kateri fizikalni pojav izkoriščamo za branje podatkov z optičnih medijev?

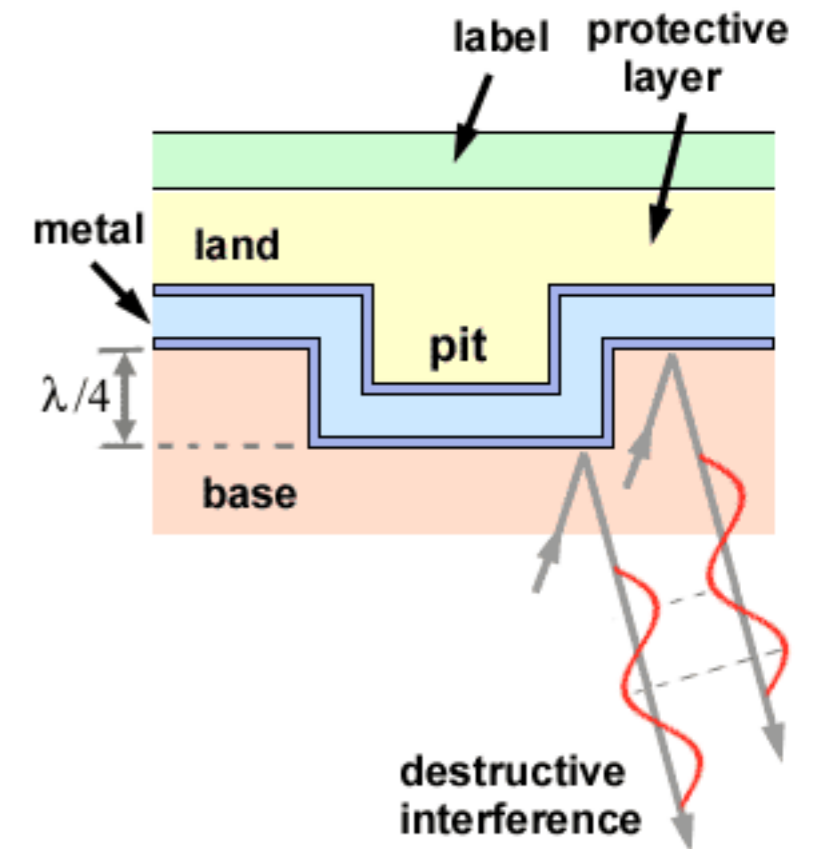
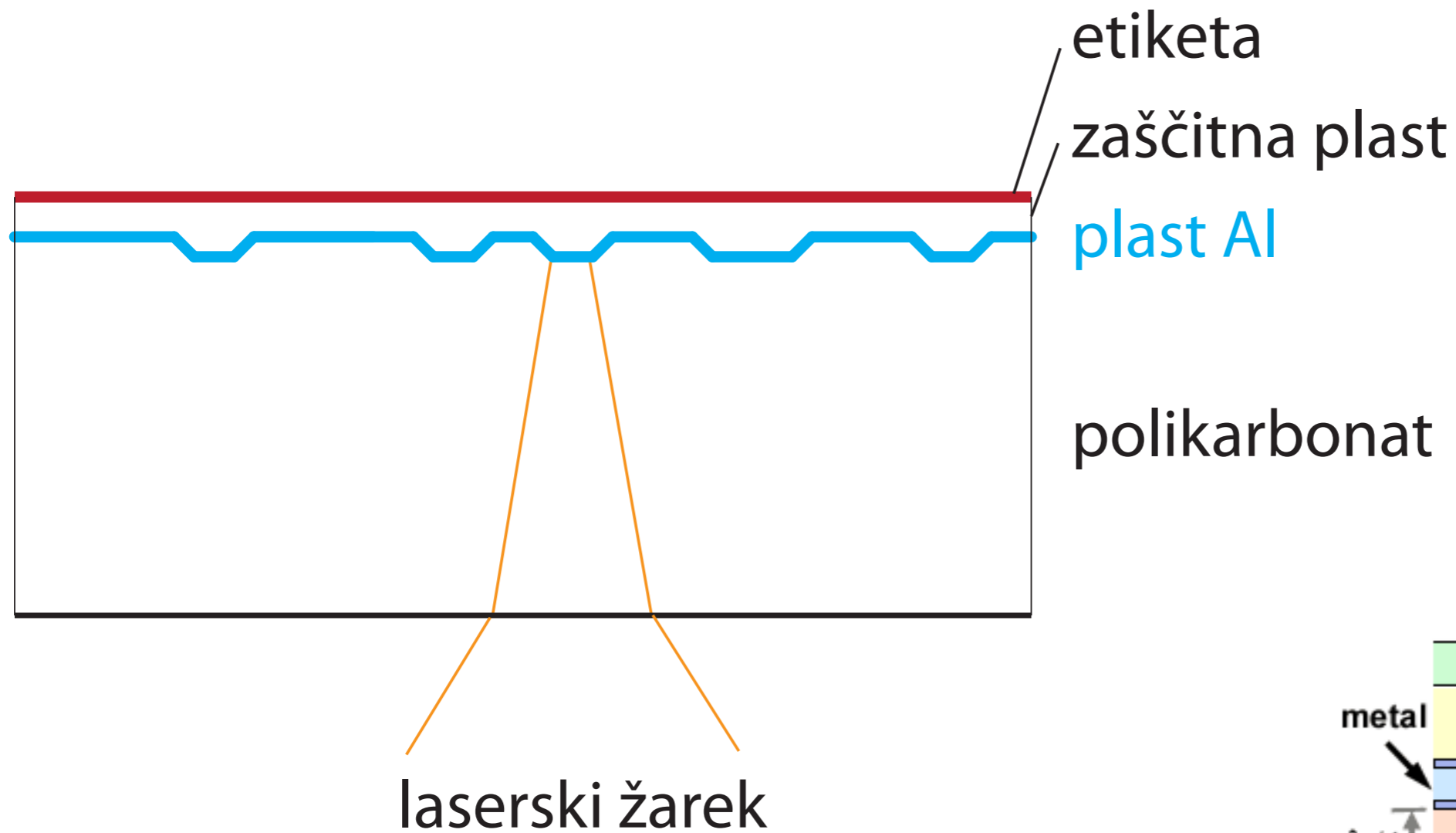

Blu-ray Disc

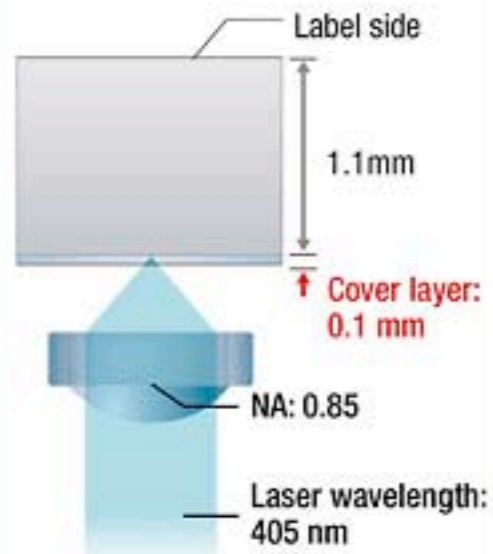

Capacity: 25GB

DVD

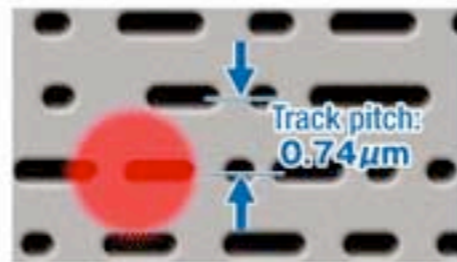
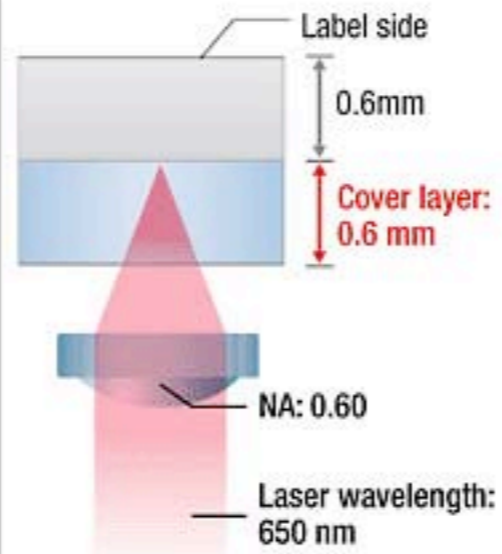

Capacity: 4.7GB

CD

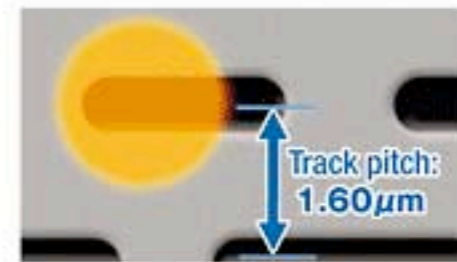
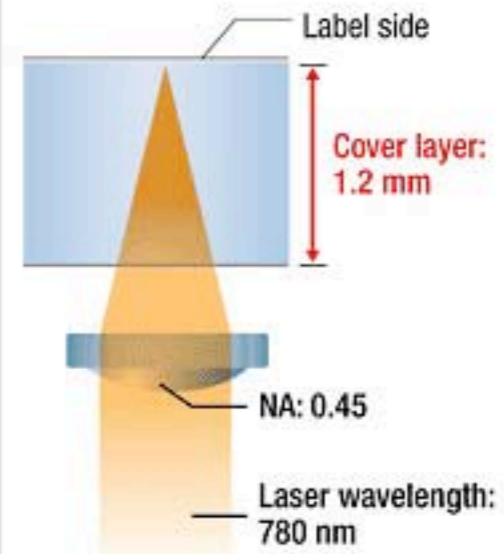

Capacity: 700MB