

POLPREVODNIKI in IZOLATORJI

Slabo prevajajo, ker je valenčni pas poln, prevodni pa prazen.
Izolativnost je posledica Paulijevega izključitvenega načela in energijske reže.

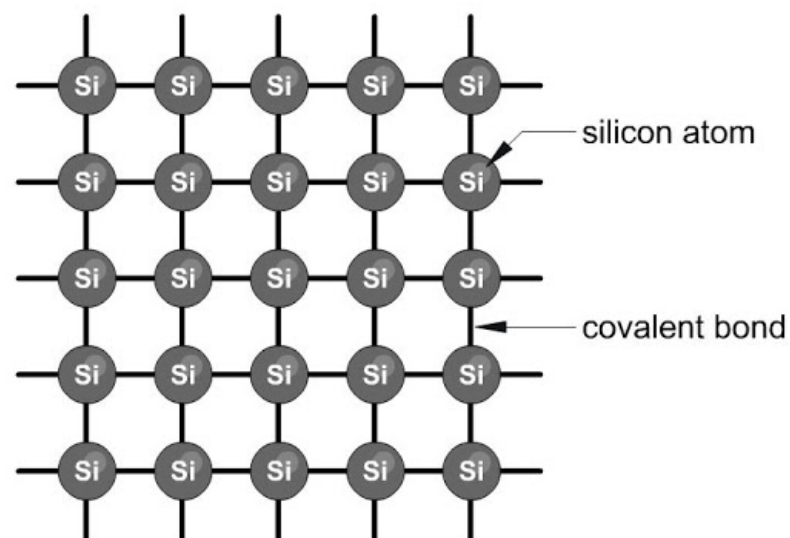

I. Katere snovi uvrščamo med polprevodnike? Kateri so najbolj pomembni?

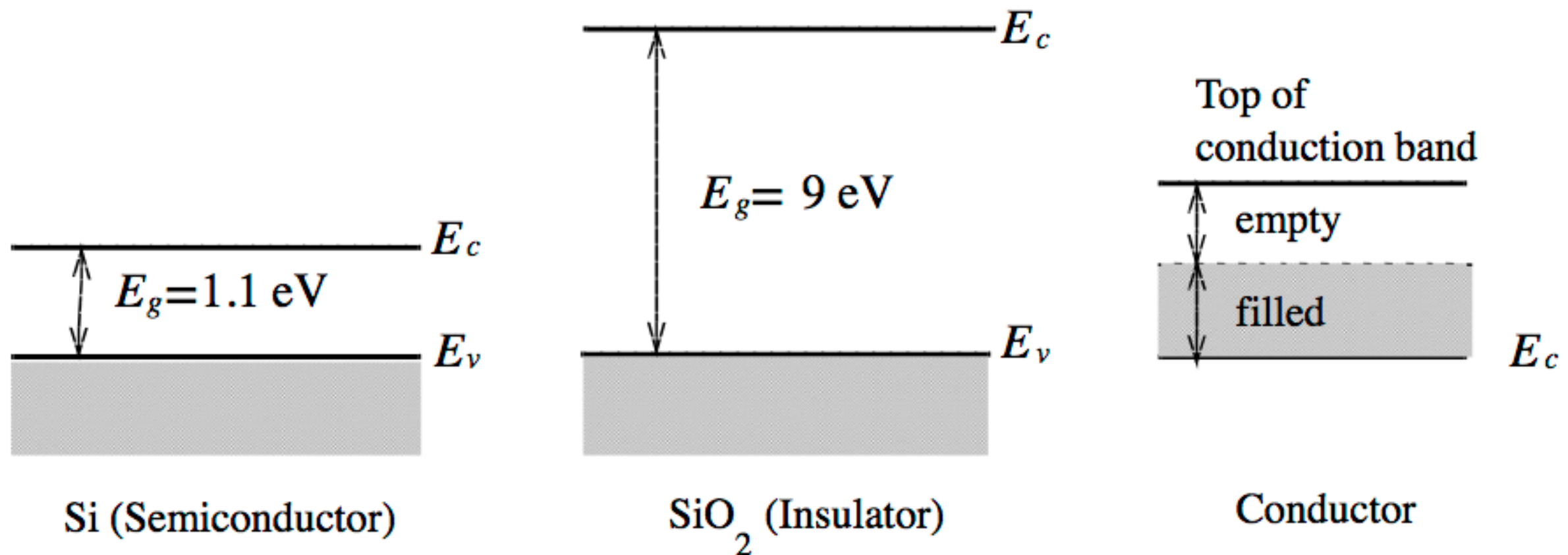

pragmatična definicija:

polprevodnik = izolator, ki mu lahko lastnosti spreminjamo z dopiranjem

snov	energijska reža E_g eV
indijev antimonid, InSb	0,17
svinčev sulfid, PbS	0,37
germanij, Ge	0,67
silicij, Si	1,11
galijev arzenid, GaAs	1,43
bakrov oksid, Cu ₂ O	2,17
kadmijev sulfid, CdS	2,42
silicijev karbid, SiC	3,3
aluminijev arzenid, AlAs	2,16
galijev nitrid, GaN	3,4
diamant, C	5,5
aluminijev nitrid, AlN	6,2

Properties of Semiconductor Materials

		E_g (eV)	μ_n (cm ² /V-s)	μ_p (cm ² /V-s)	m_e^*/m_0 (m_1, m_2)	m_p^*/m_0 (m_{b1}, m_{b2})	a (Å)	ϵ_r	Density (g/cm ³)	Melting point (°C)
Si	(i/D)	1.11	1350	480	0.98, 0.19	0.16, 0.49	5.43	11.8	2.33	1415
Ge	(i/D)	0.67	3900	1900	1.64, 0.082	0.04, 0.28	5.65	16	5.32	936
SiC (α)	(i/W)	2.86	500	—	0.6	1.0	3.08	10.2	3.21	2830
AlP	(i/Z)	2.45	80	—	—	0.2, 0.63	5.46	9.8	2.40	2000
AlAs	(i/Z)	2.16	1200	420	2.0	0.15, 0.76	5.66	10.9	3.60	1740
AlSb	(i/Z)	1.6	200	300	0.12	0.98	6.14	11.0	4.26	1080
GaP	(i/Z)	2.26	300	150	1.12, 0.22	0.14, 0.79	5.45	11.1	4.13	1467
GaAs	(d/Z)	1.43	8500	400	0.067	0.074, 0.50	5.65	13.2	5.31	1238
GaN	(d/Z, W)	3.4	380	—	0.19	0.60	4.5	12.2	6.1	2530
GaSb	(d/Z)	0.7	5000	1000	0.042	0.06, 0.23	6.09	15.7	5.61	712
InP	(d/Z)	1.35	4000	100	0.077	0.089, 0.85	5.87	12.4	4.79	1070
InAs	(d/Z)	0.36	22600	200	0.023	0.025, 0.41	6.06	14.6	5.67	943
InSb	(d/Z)	0.18	10 ⁵	1700	0.014	0.015, 0.40	6.48	17.7	5.78	525
ZnS	(d/Z, W)	3.6	180	10	0.28	—	5.409	8.9	4.09	1650*
ZnSe	(d/Z)	2.7	600	28	0.14	0.60	5.671	9.2	5.65	1100*
ZnTe	(d/Z)	2.25	530	100	0.18	0.65	6.101	10.4	5.51	1238*
CdS	(d/W, Z)	2.42	250	15	0.21	0.80	4.137	8.9	4.82	1475
CdSe	(d/W)	1.73	800	—	0.13	0.45	4.30	10.2	5.81	1258
CdTe	(d/Z)	1.58	1050	100	0.10	0.37	6.482	10.2	6.20	1098
PbS	(i/H)	0.37	575	200	0.22	0.29	5.936	17.0	7.6	1119
PbSe	(i/H)	0.27	1500	1500	—	—	6.147	23.6	8.73	1081
PbTe	(i/H)	0.29	6000	4000	0.17	0.20	6.452	30	8.16	925

Binarne spojine

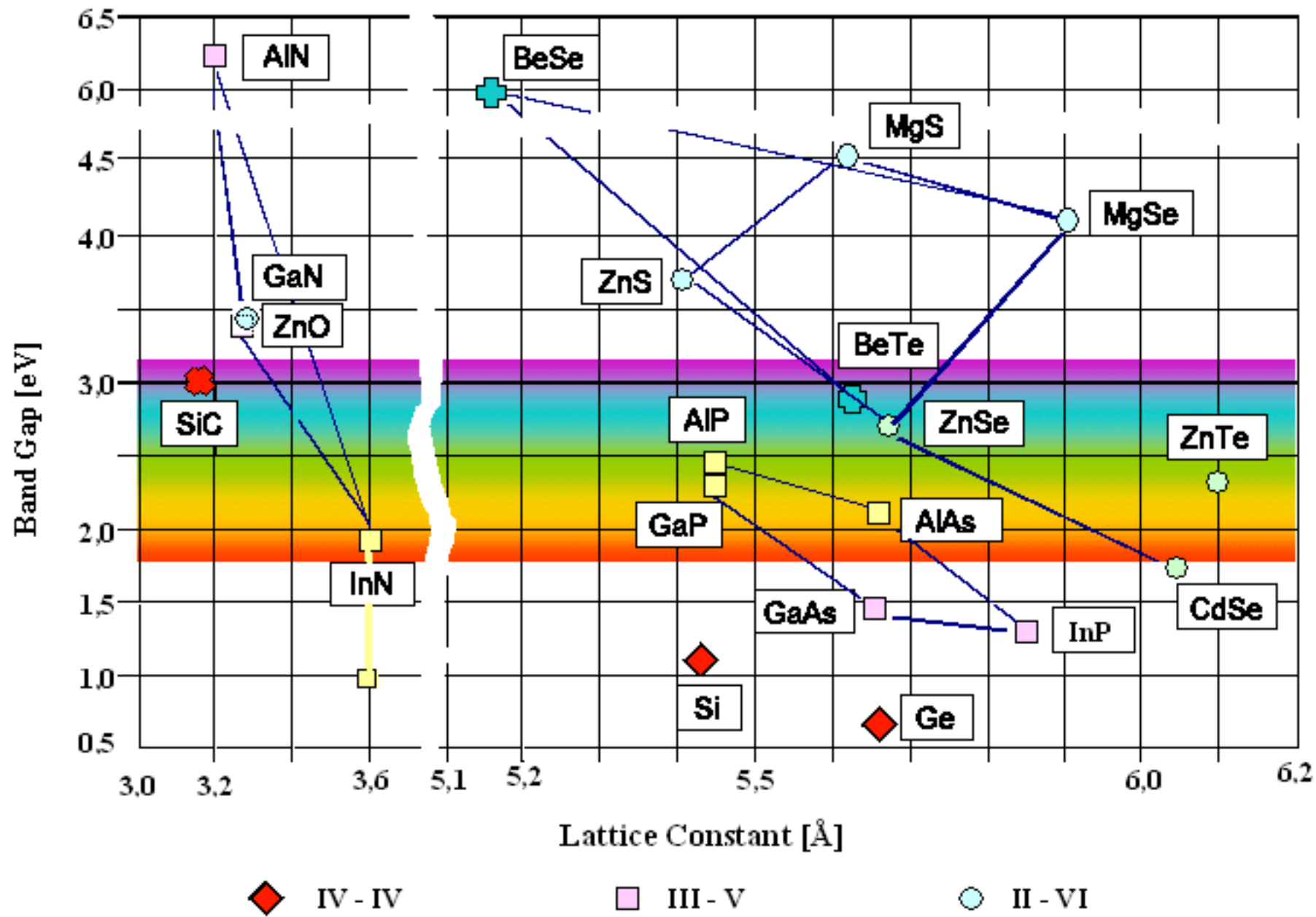

optične naprave!

Organski polprevodniki

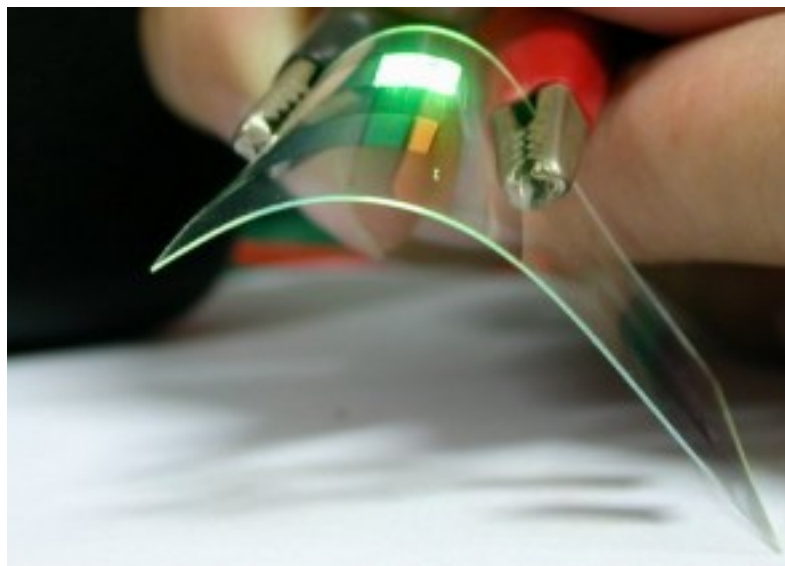

2. Kaj je vrzel? Kakšen naboj ima? Kako se giba?



Manjkajoči elektroni, ki se obnaša kot delec (**kvazidelec**).

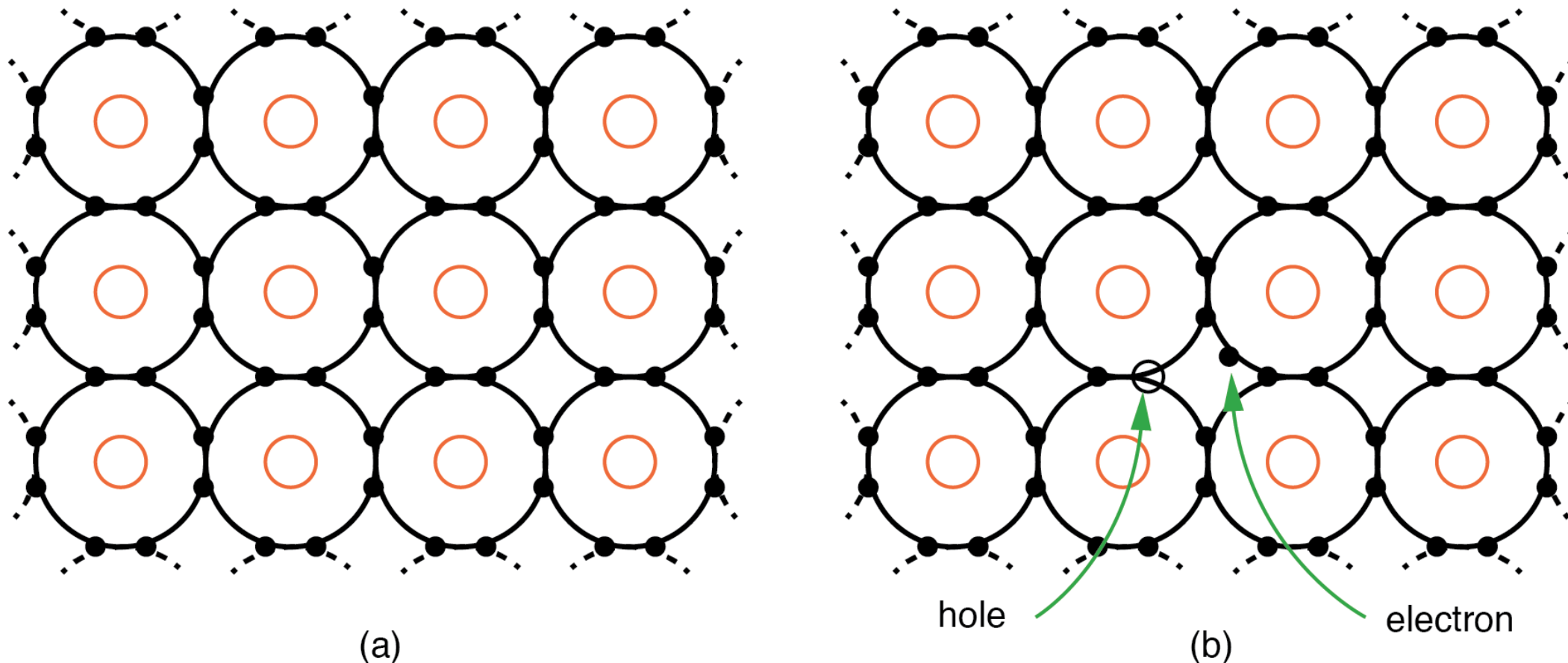

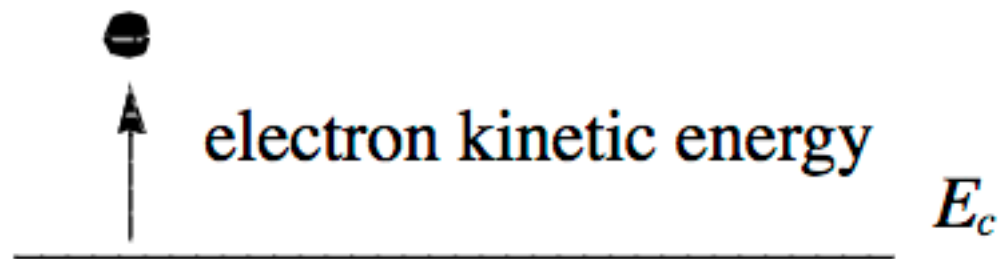

"pada" na dno pasu

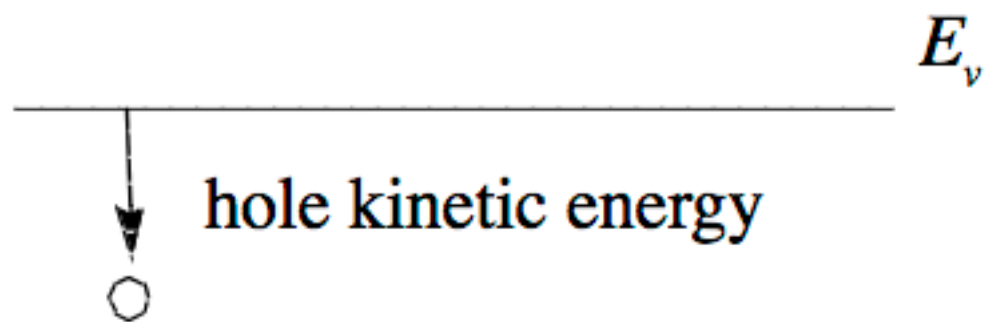

"vzpenja se" na vrg pasu
(kot mehurček plina v vrčku piva!)

3. Zakaj elektron in vrzel nastaneta v paru? Kaj se zgodi z razliko energij ob rekombinaciji?

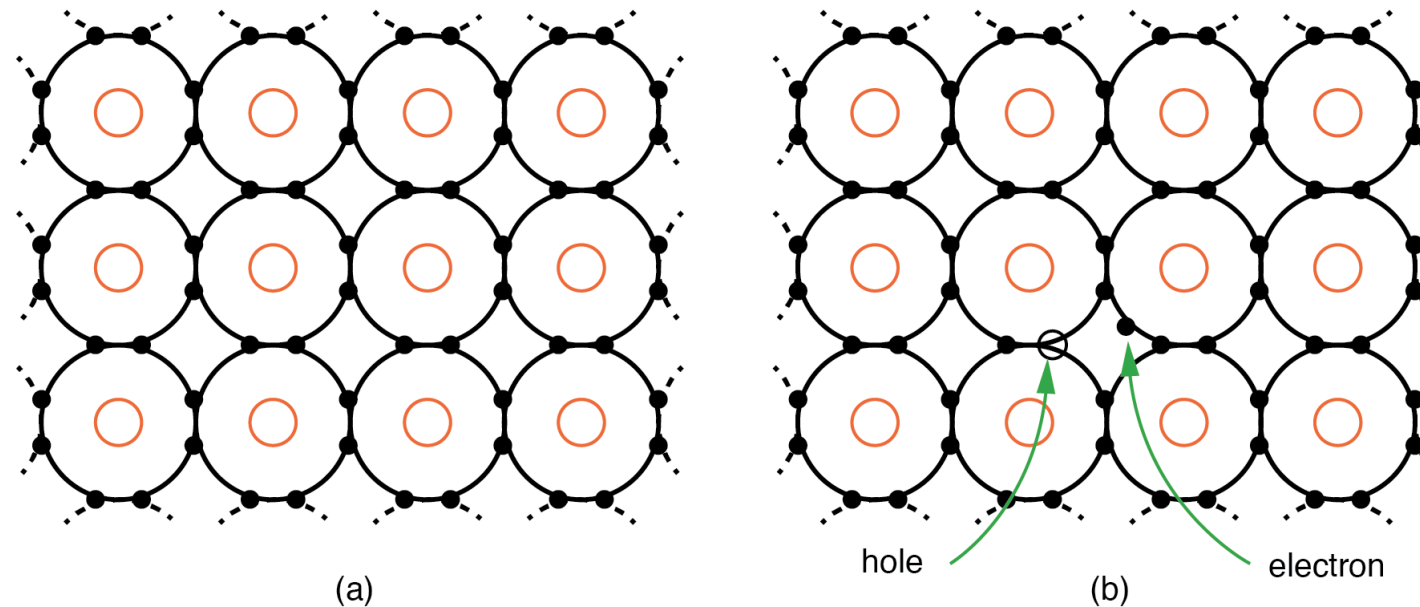

Presežek energije: **toplota** ali **svetloba** (foton!).

4. Od česa je odvisna prevodnost polprevodnikov?
Kako lahko vplivamo nanjo?

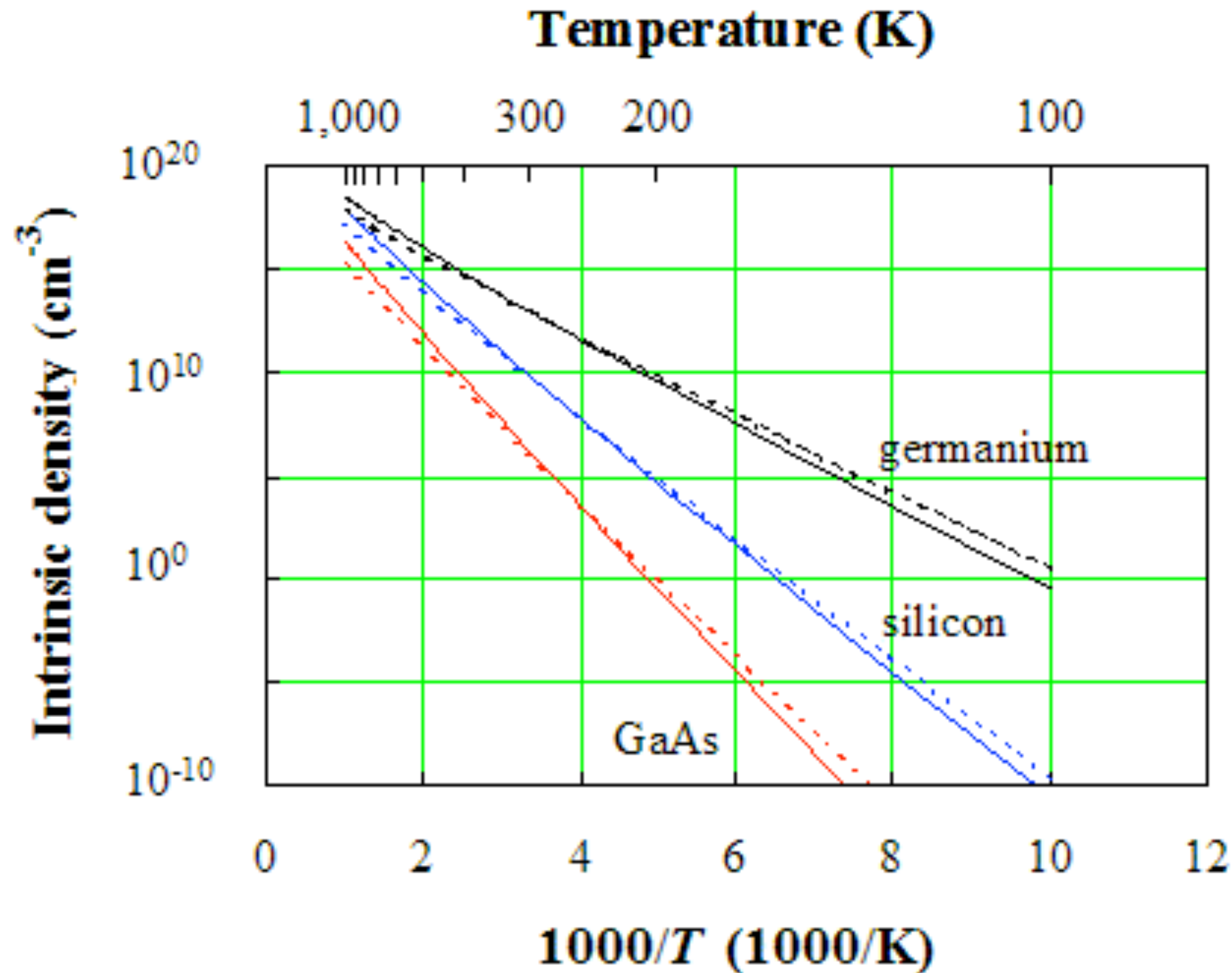

Gibljivost in prevodnost

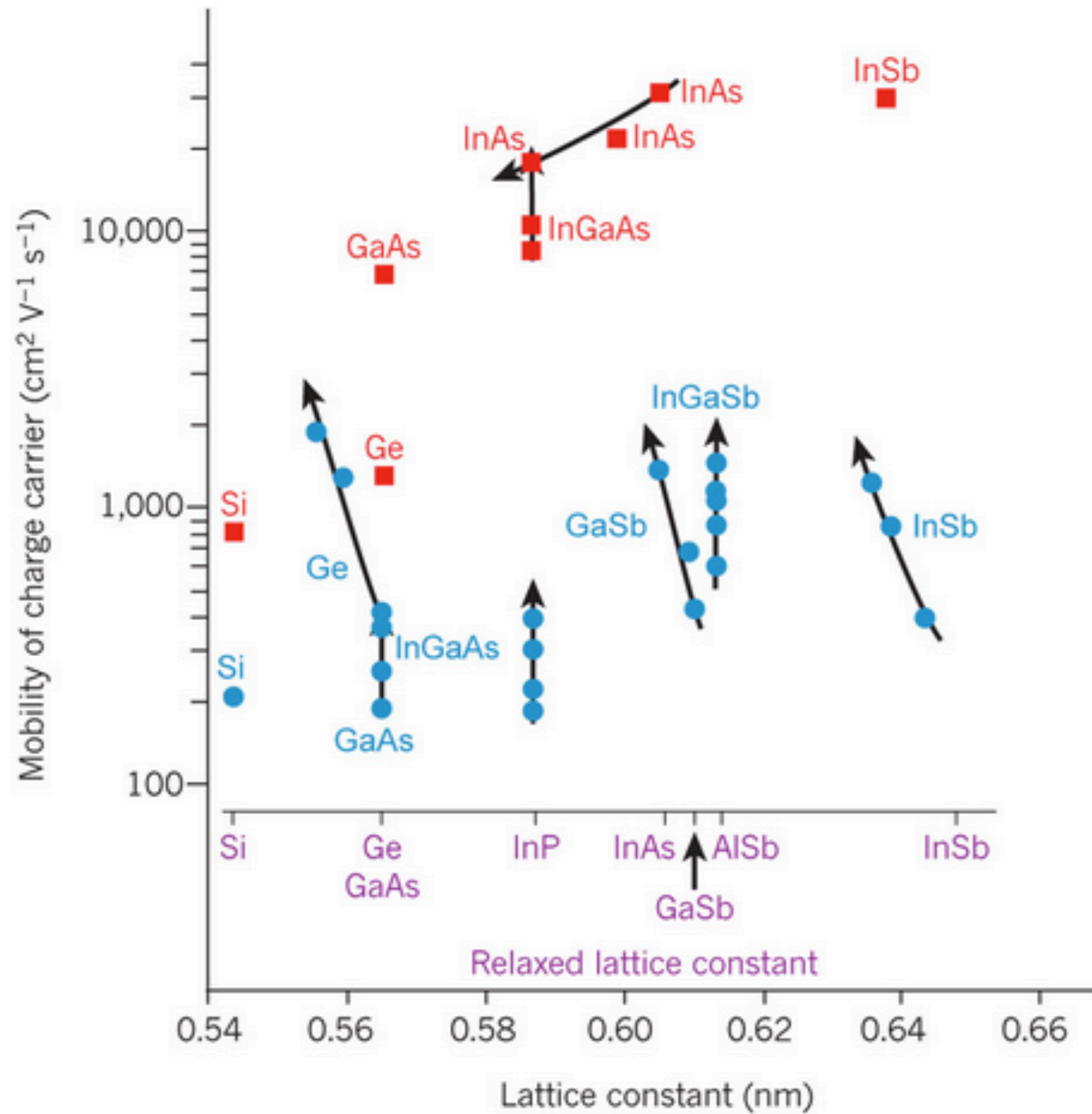

5. Kako dopirano polprevodnike? Kaj s tem dosežemo?

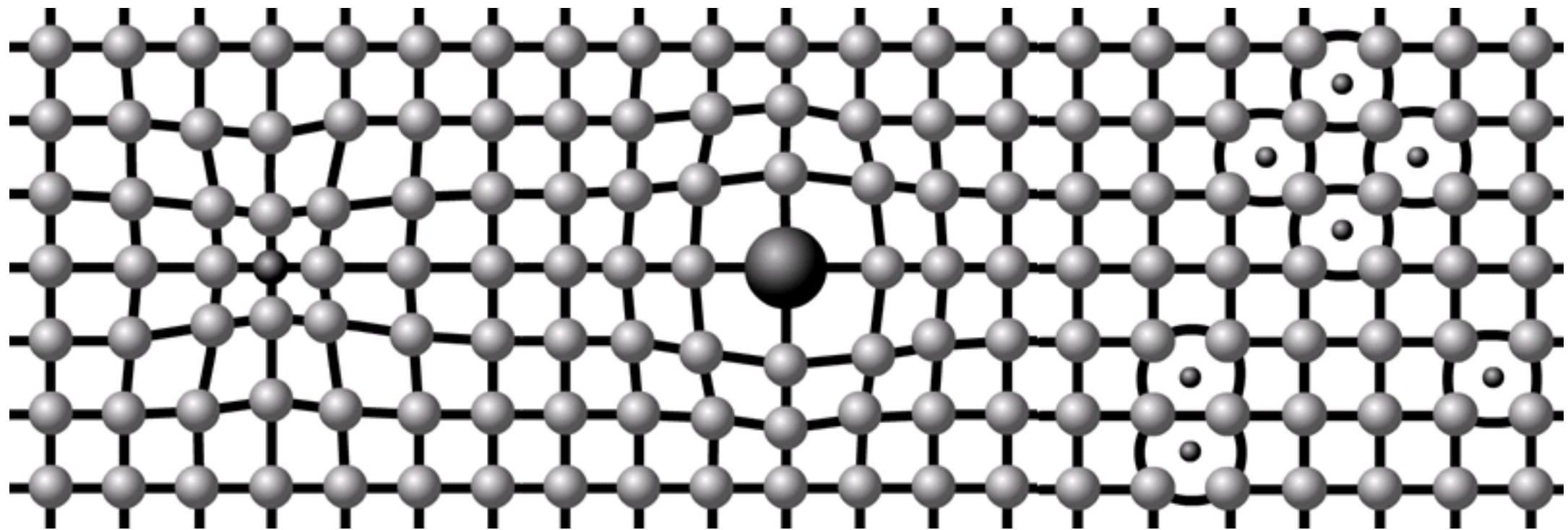

substitucijski

intersticijski

III

IV

V

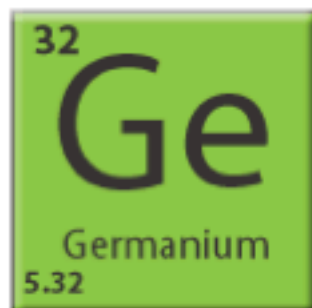
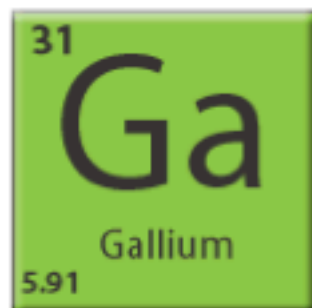
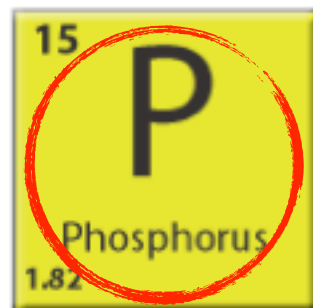
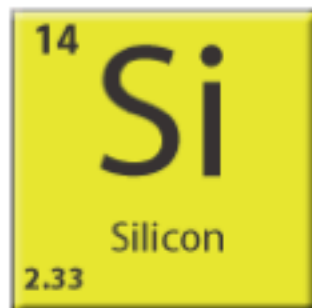
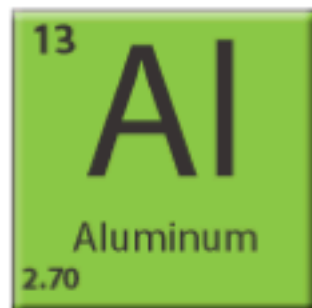
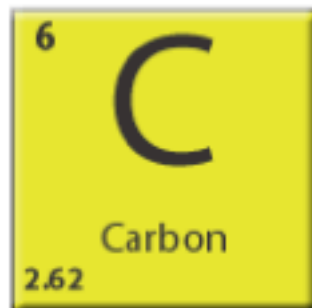

©2001 HowStuffWorks



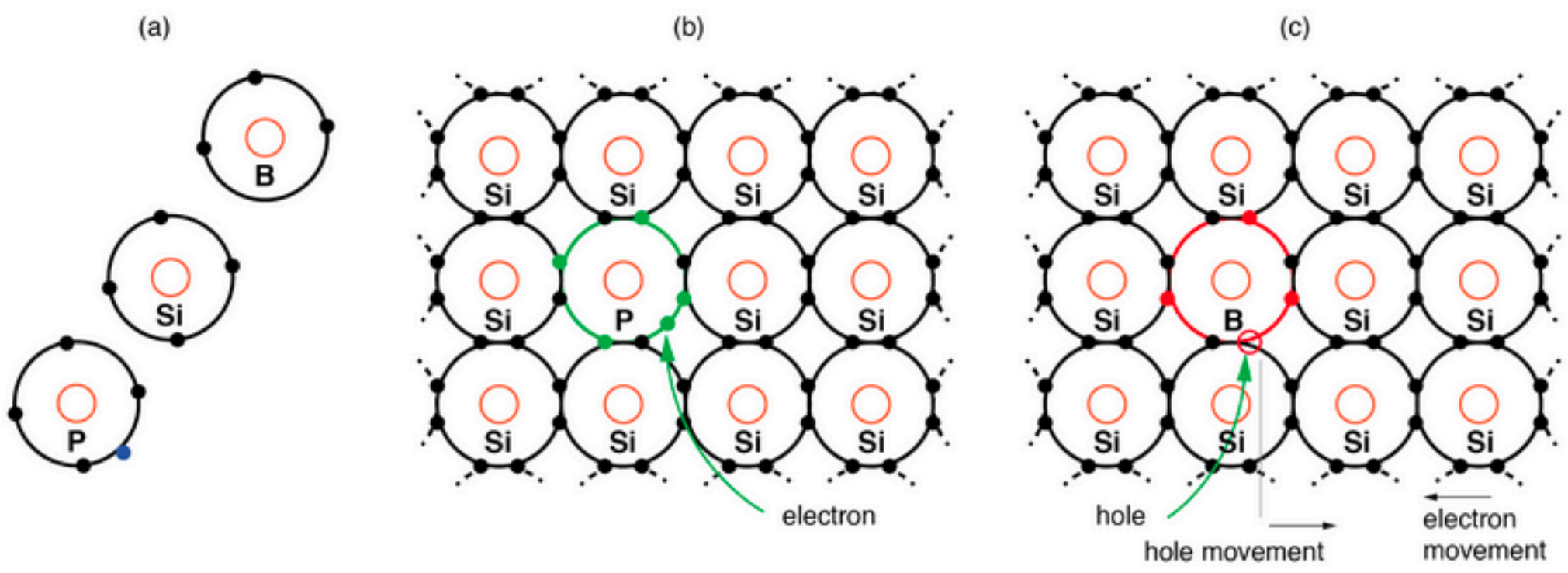

dopant gas $\text{AsH}_3, \text{PH}_3, \text{B}_2\text{H}_6$

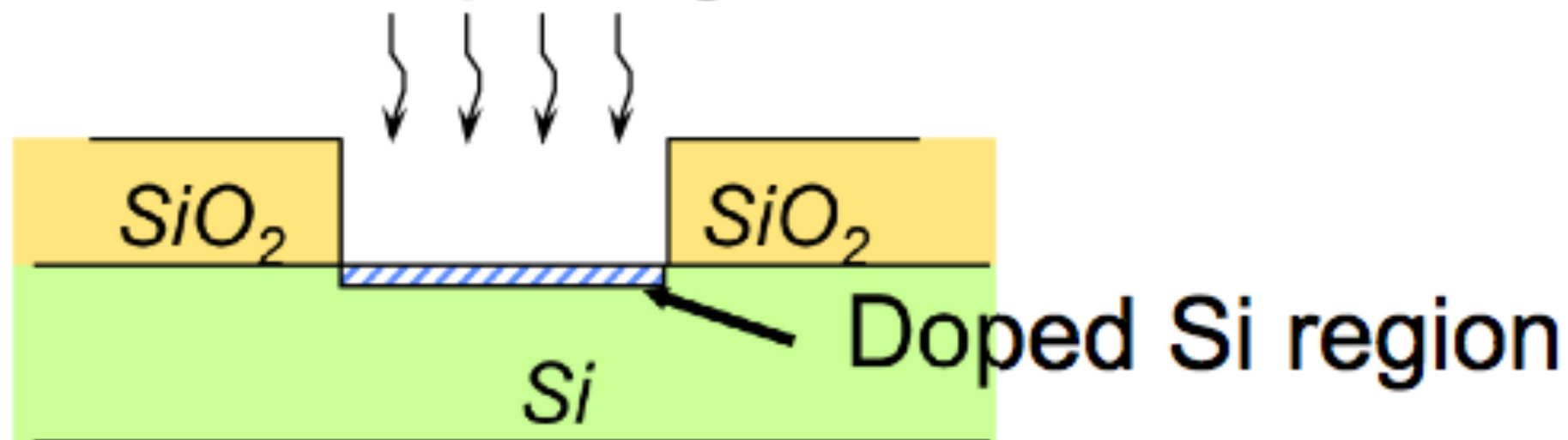

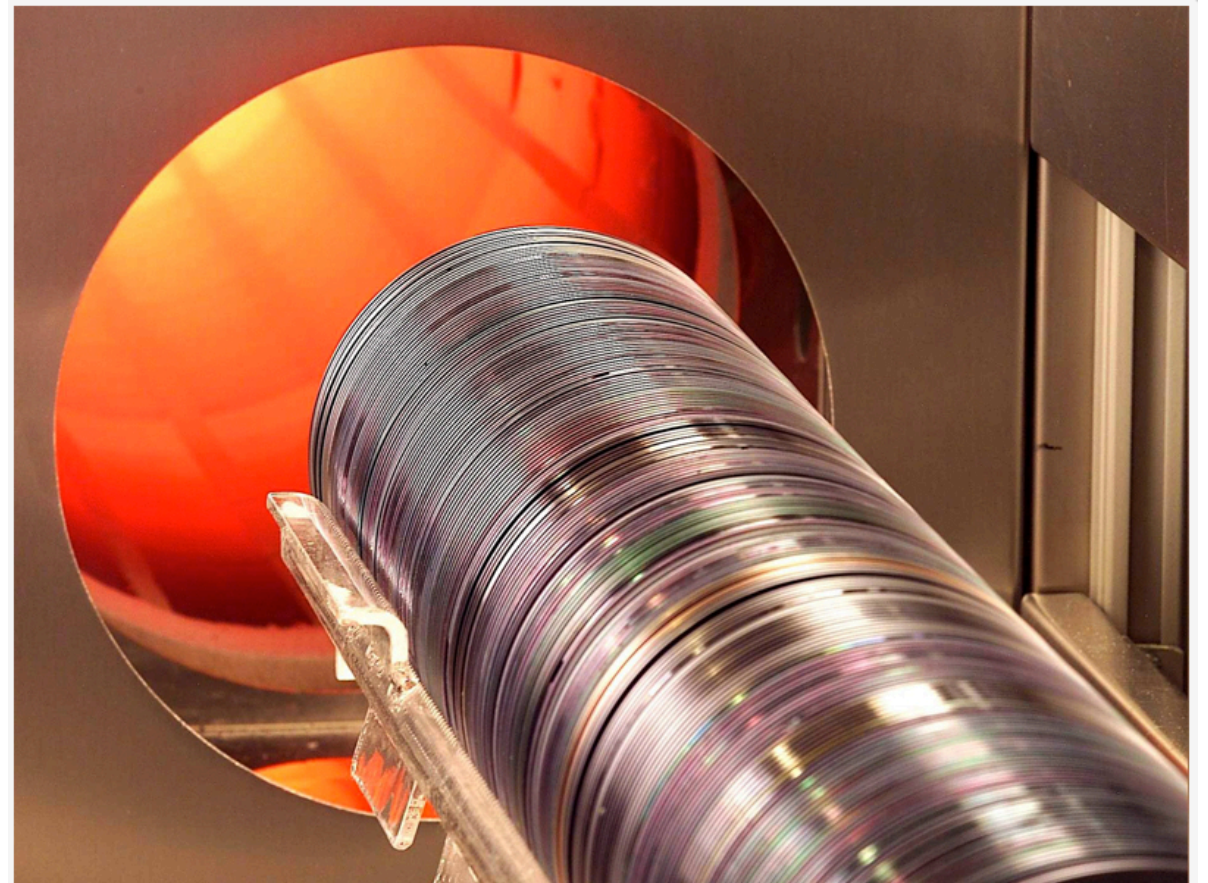
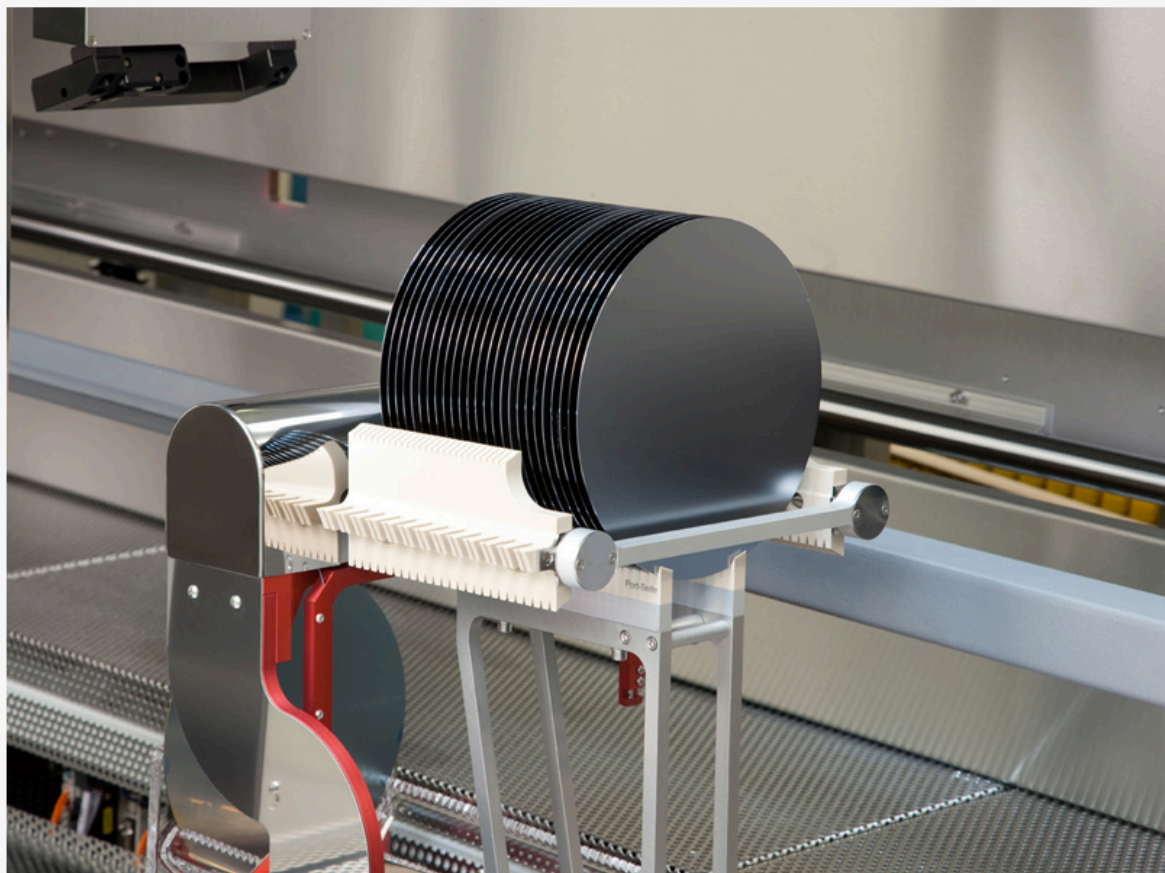

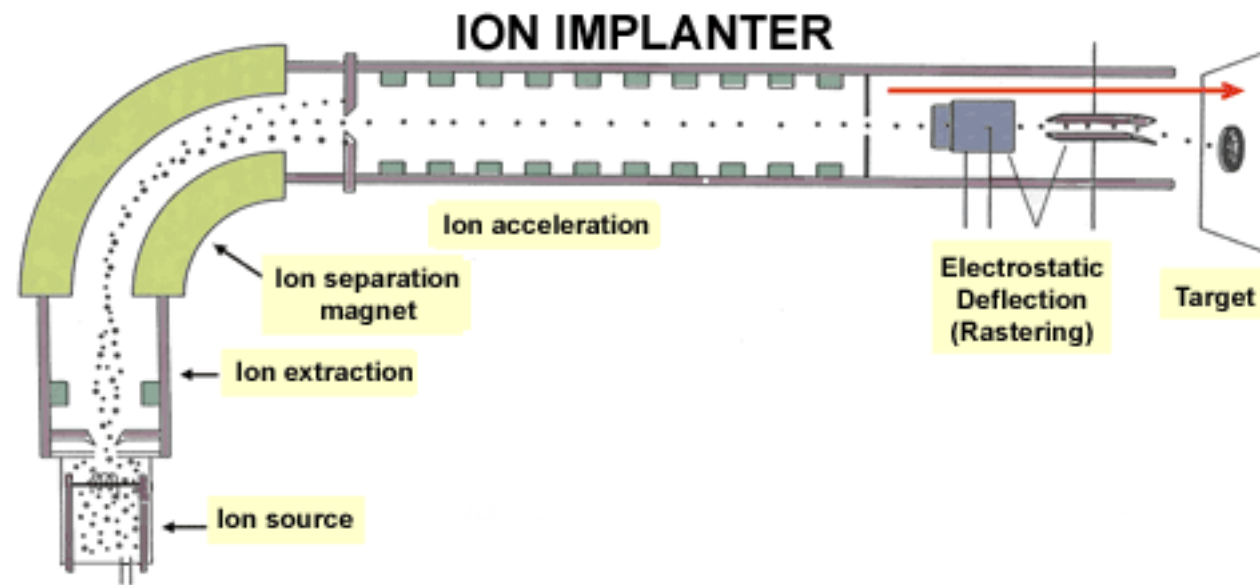

Ideja: Shockley 1954,
masovna proizvodnja 1970+

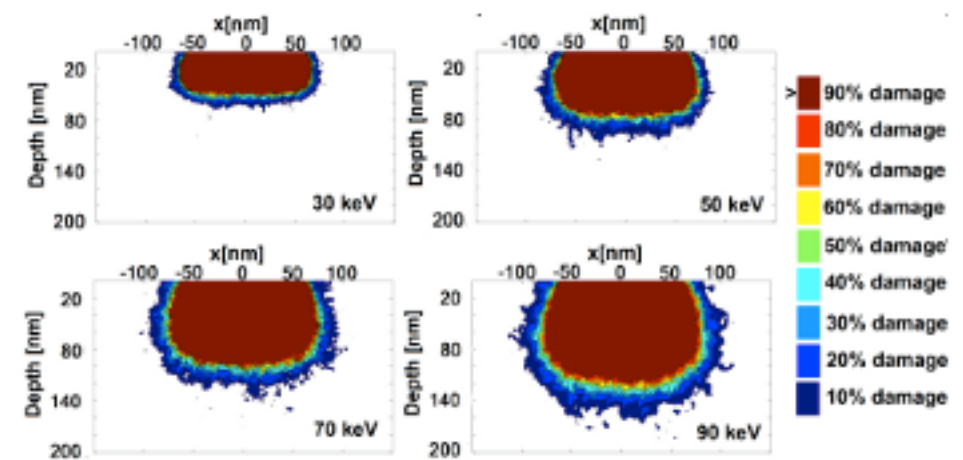
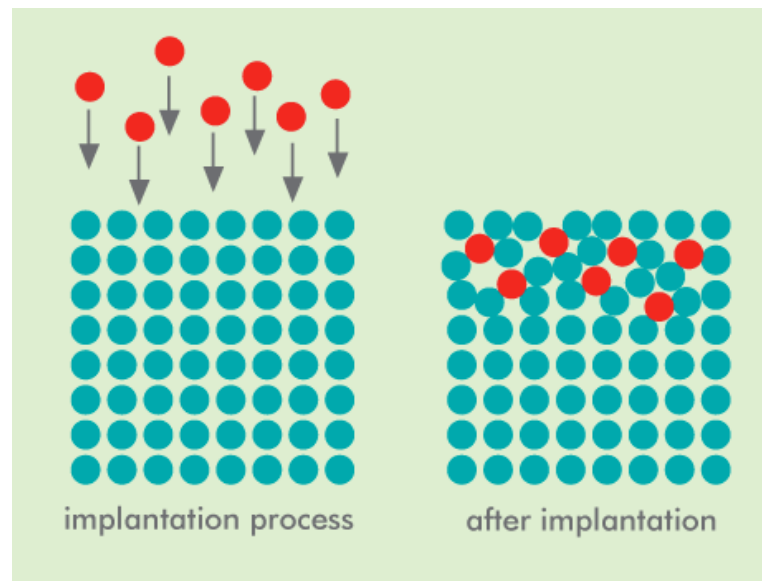

Domet: nekaj 100nm

Prednosti:

- poteka pri nizkih temperaturah
- hitrost
- natančno doziranje
- poljubna koncentracija dopantov
- enakomernost



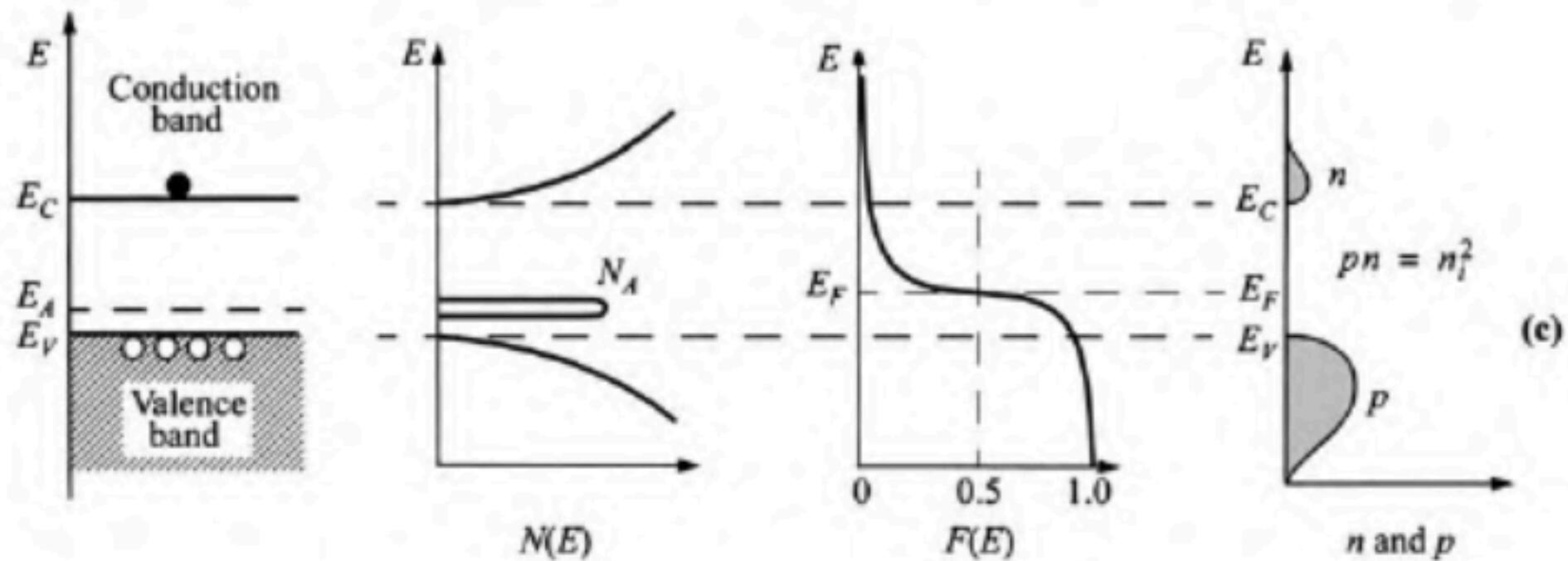
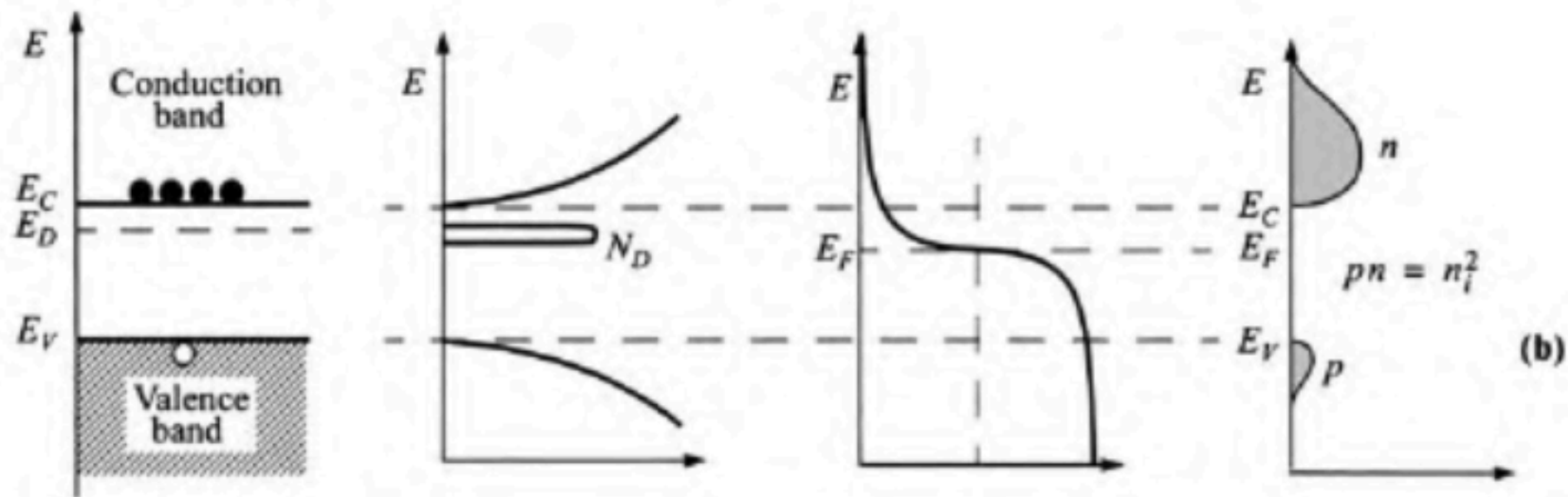
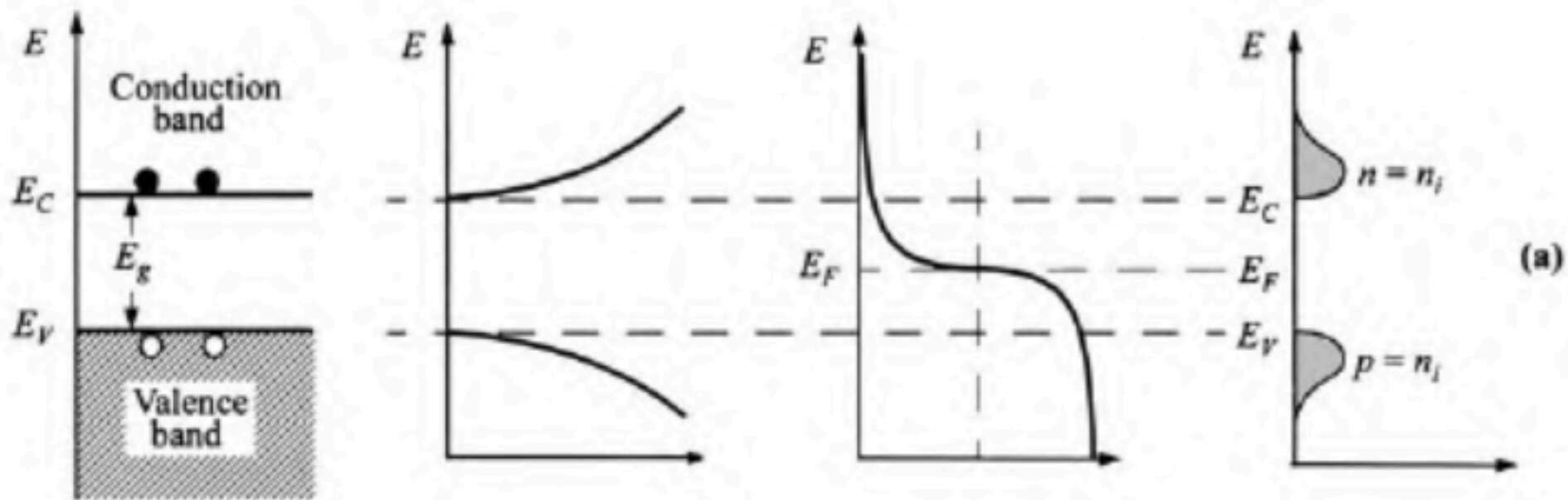

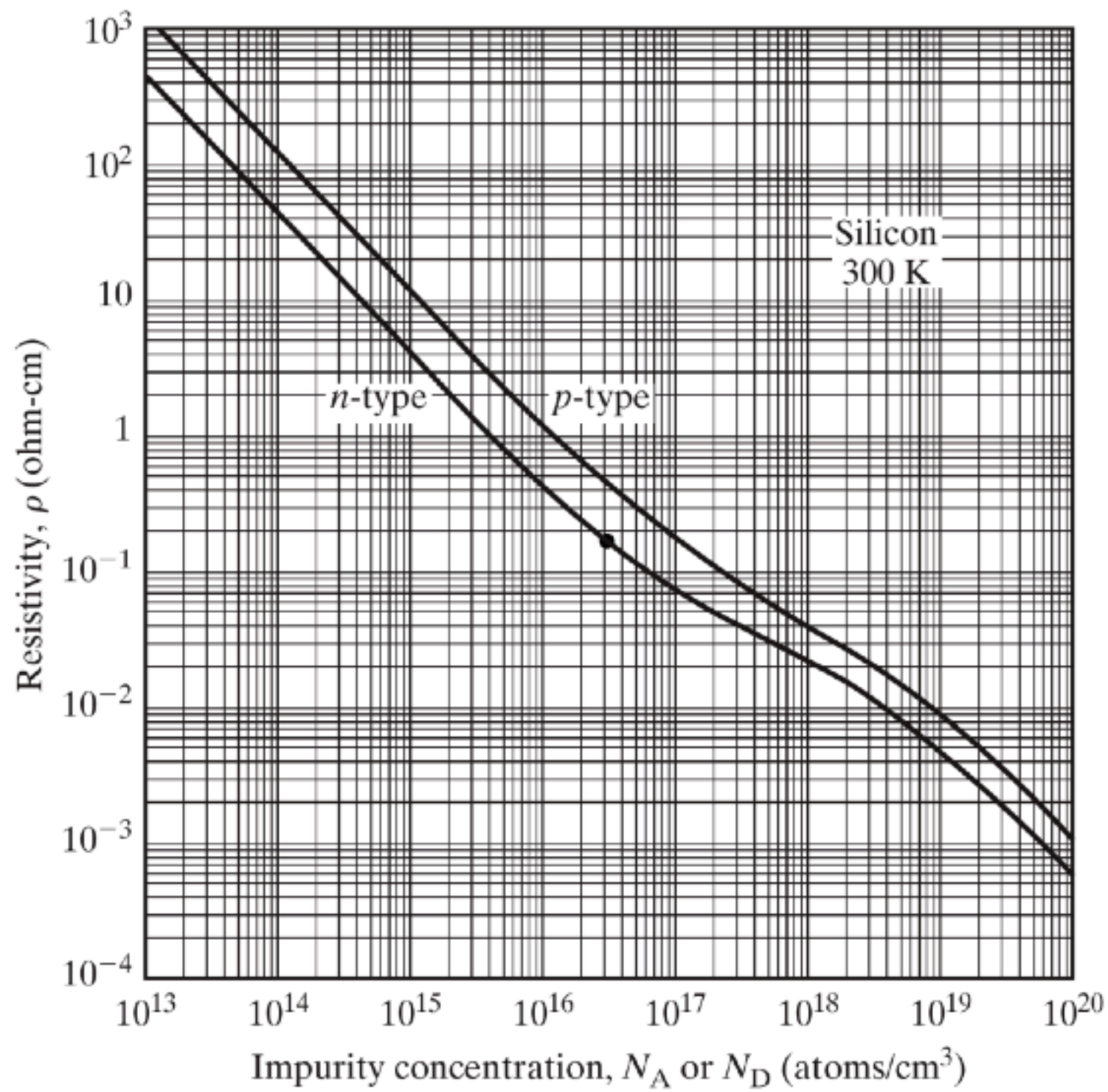

6. Iz katerih razlogov so materiali lahko izolatorski?

The Nobel Prize in Physics 1977



Philip Warren
Anderson
Prize share: 1/3



Sir Nevill Francis
Mott
Prize share: 1/3



John Hasbrouck van
Vleck
Prize share: 1/3

The Nobel Prize in Physics 1977 was awarded jointly to Philip Warren Anderson, Sir Nevill Francis Mott and John Hasbrouck van Vleck *"for their fundamental theoretical investigations of the electronic structure of magnetic and disordered systems"*.

6) IZOLATORJI

- pasarni izolatorji: kristali z $E_{\text{gap}} \gtrsim 4 \text{ eV}$. Sodo št. el. na celico.

- Mottovi izolatorji: $\uparrow \downarrow \rightarrow - \uparrow \downarrow$ dodatna energija U
 U velike \rightarrow snov izolator. Če liho št. el. na celico.

Prehod kovina-izolator v odvisnosti od p ali T .

Cu_2O , V_2O_3 , kuprati.

Močno korelirani elektonski sistemi, kvantni material.

\hookrightarrow zelo zapleteno odnasanje, ker možna različna osnovna stanja, med katerimi zelo majhne energijske razlike.

- Mott, Andersonovi izolatorji: valovne funkcije niso ravn valovi, temveč eksponentno upadajoče (lokalizirane).

Dielektrični preboj v močnem polju.

SiO_2 $E_g = 9 \text{ eV}$ visoka prebojna jakost preprosta priprava

Gauss-Bonnetov izrek

Eulerjeva karakteristika $\chi = \frac{1}{2\pi} \int dS K$

Gaussova ukrivljenost ploskve, $K=1/R_1R_2$

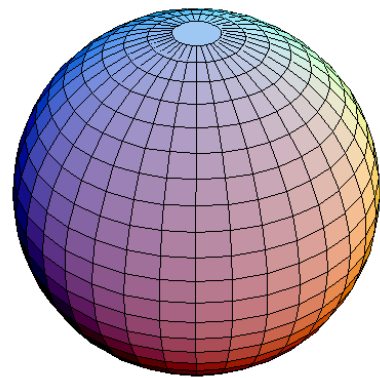

Sfera $\chi=2$

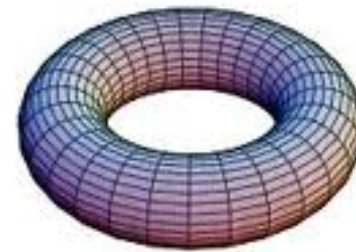

Torus $\chi=0$

